

## A\_ZONE ZAHVATA

### TISSA & PARTNERS

---

Rade Končara 1a, 52440 Poreč  
tissa@tissa.hr  
+385 52 431 552

[www.tissa.hr](http://www.tissa.hr)

---







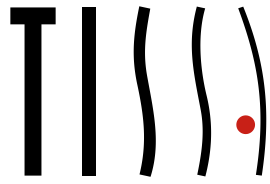

**A\_Rušenja i novo**

## TISSA & PARTNERS

---

Rade Končara 1a, 52440 Poreč  
tissa@tissa.hr  
+385 52 431 552

[www.tissa.hr](http://www.tissa.hr)

---



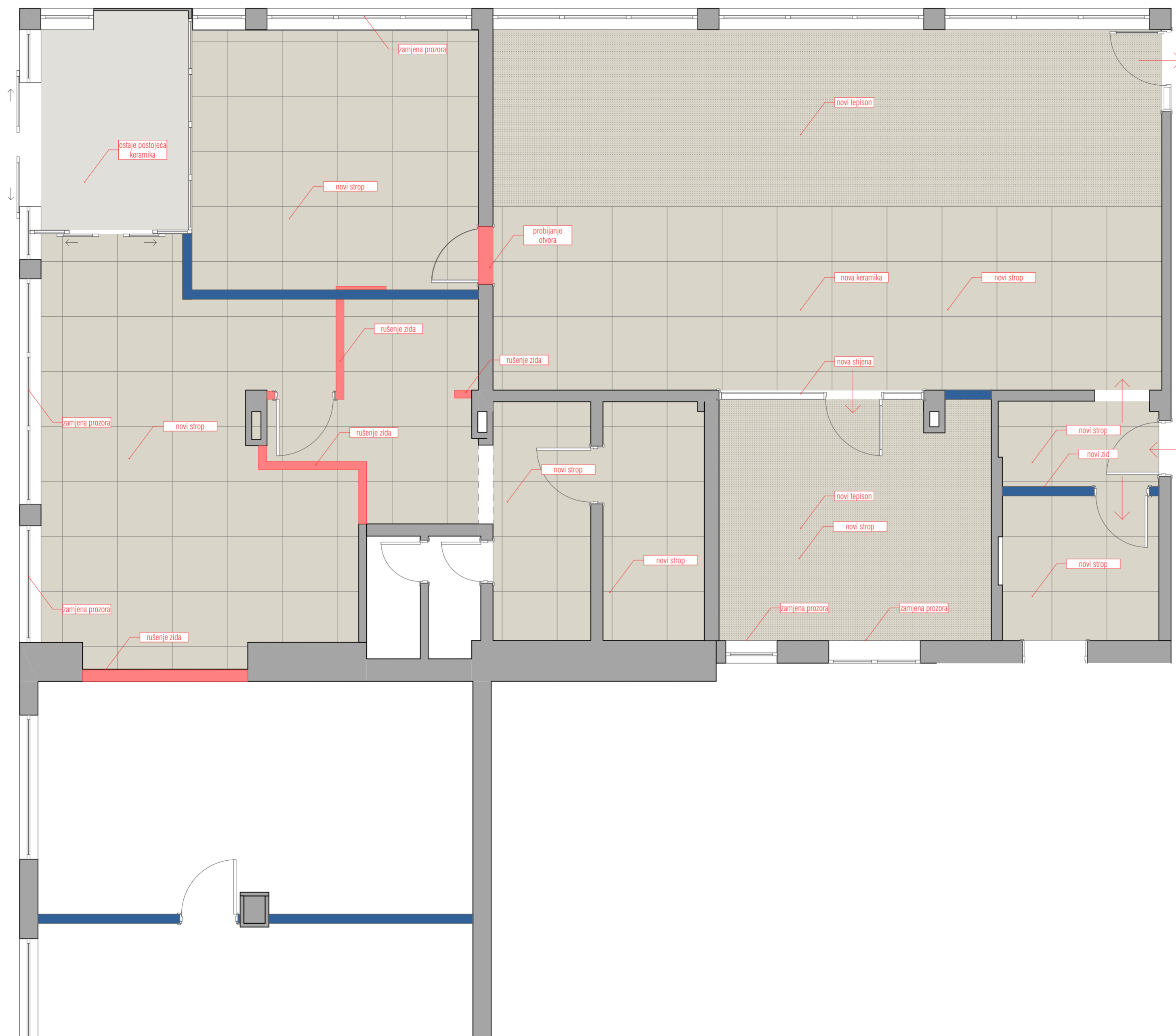

**ZONA 1** **ZONA 2**

|   |                                 |                |
|---|---------------------------------|----------------|
| <b>TISSA &amp; PARTNERS</b>   |                                 |                |
| naziv građevine<br>1111_EMONIA  |                                 |                |
| investitor<br>Aminess Novigrad  |                                 |                |
| strukovna odrednica / naziv projekta<br>Interijer / Izvedbeni projekt | broj projekta<br>1111-02/25-IZI | datum<br>II/25 |
| projektant<br>ind. diz. Višen Slamar, Nina Štifanić mag. ing. arh.    |                                 |                |
| sadržaj<br>Rušenja i novo_ZONA_1 i ZONA_2                             | mjerilo<br>1:50                 | list<br>A.2    |

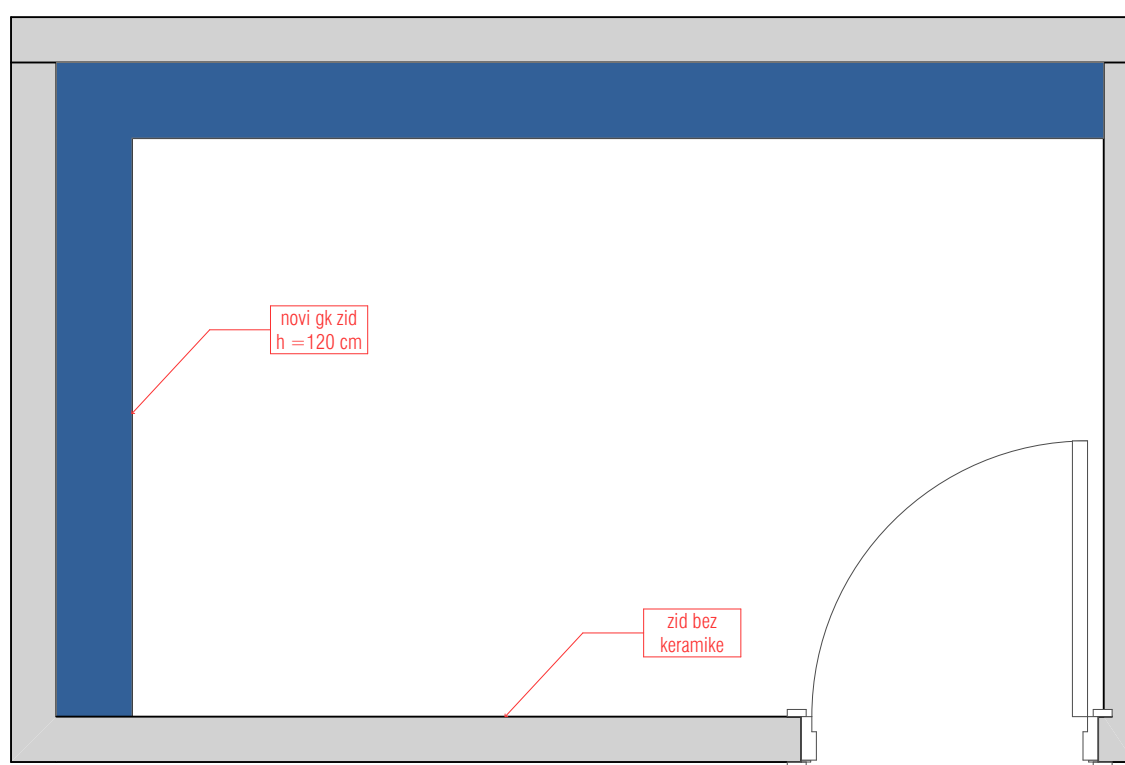
**ZONA 5**

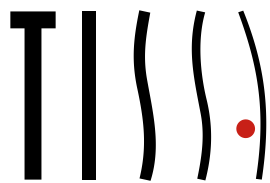

## A\_Spušteni stropovi

### TISSA & PARTNERS

---

Rade Končara 1a, 52440 Poreč  
tissa@tissa.hr  
+385 52 431 552

[www.tissa.hr](http://www.tissa.hr)

---



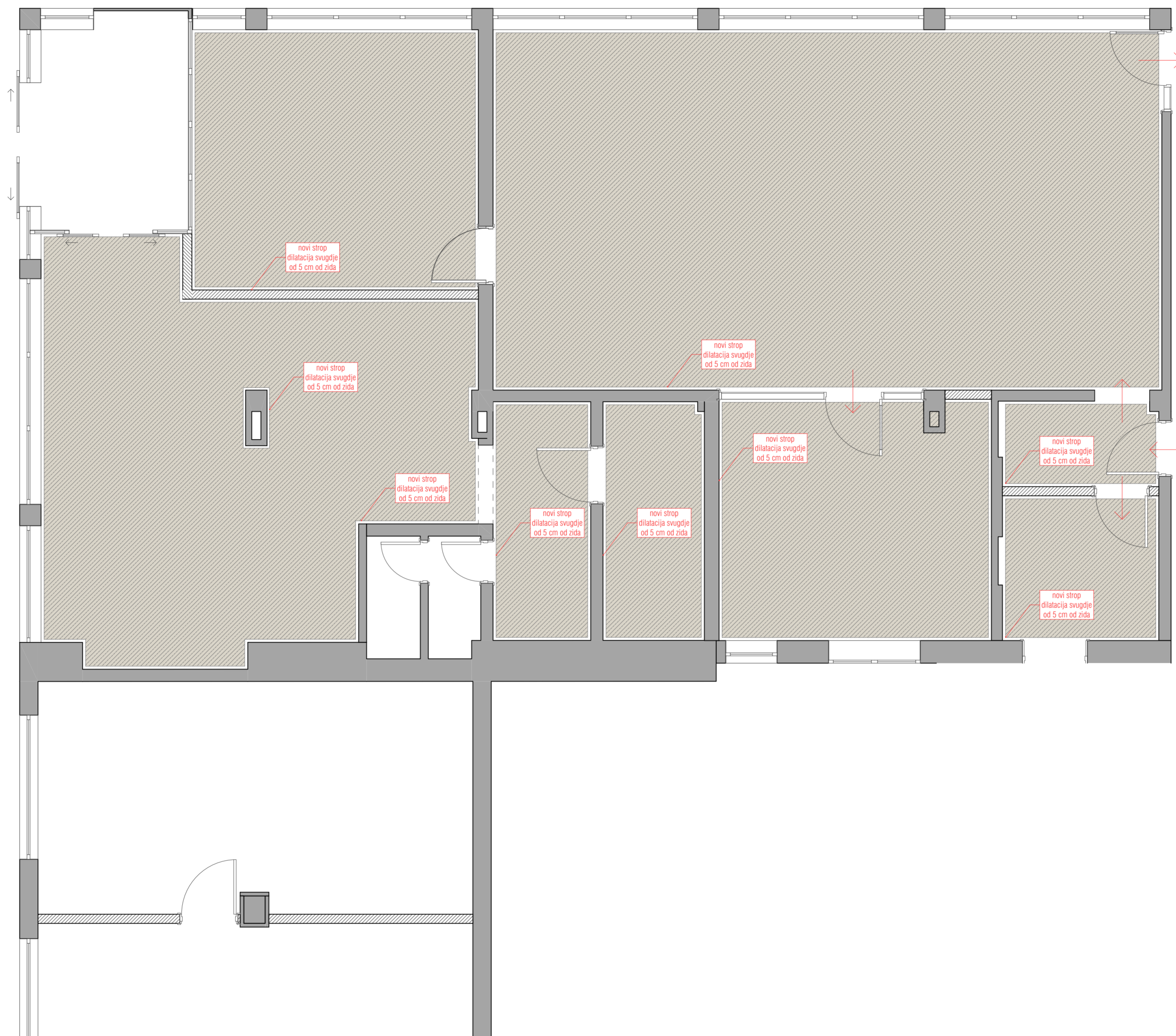

**ZONA 1** **ZONA 2**

|   |                                 |                |
|---|---------------------------------|----------------|
| <b>TISSA &amp; PARTNERS</b>   |                                 |                |
| naziv građevine<br>1111_EMONIA  |                                 |                |
| investitor<br>Amines Novigrad   |                                 |                |
| strukovna odrednica / naziv projekta<br>Interijer / Izvedbeni projekt | broj projekta<br>1111-02/25-IZI | datum<br>II/25 |
| projektant<br>ind. diz. Višen Slamar, Nina Štifanić mag. ing. arh.    |                                 |                |
| sadržaj<br>Spušteni stropovi_ZONA_1 i ZONA_2                          | mjerilo<br>1:50                 | list<br>A.2    |

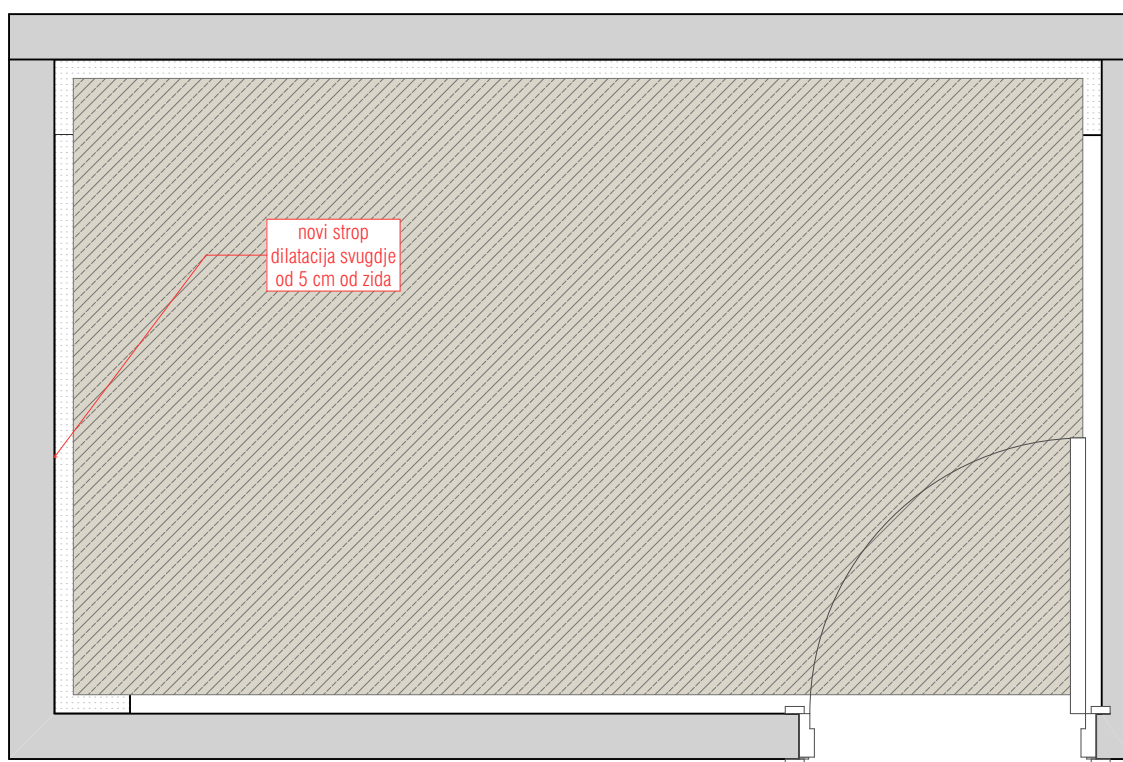
**ZONA 5**

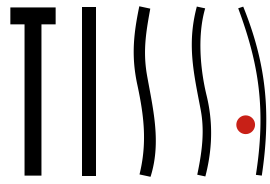

**A\_Bravarija**

## TISSA & PARTNERS

---

Rade Končara 1a, 52440 Poreč  
tissa@tissa.hr  
+385 52 431 552

[www.tissa.hr](http://www.tissa.hr)

---





ZONA 1 ZONA 2

|   |                                 |                |
|---|---------------------------------|----------------|
| <b>TISSA &amp; PARTNERS</b>   |                                 |                |
| naziv građevine<br>1111_EMONIA  |                                 |                |
| investitor<br>Aminess Novigrad  |                                 |                |
| strukovna odrednica / naziv projekta<br>Interijer / Izvedbeni projekt | broj projekta<br>1111-02/25-IZI | datum<br>II/25 |
| projektant<br>ind. diz. Višen Slamar, Nina Štifanić mag. ing. arh.    |                                 |                |
| sadržaj<br>Bravarija_ZONA_1 i ZONA_2                                  | mjerilo<br>1:50                 | list<br>A.01   |

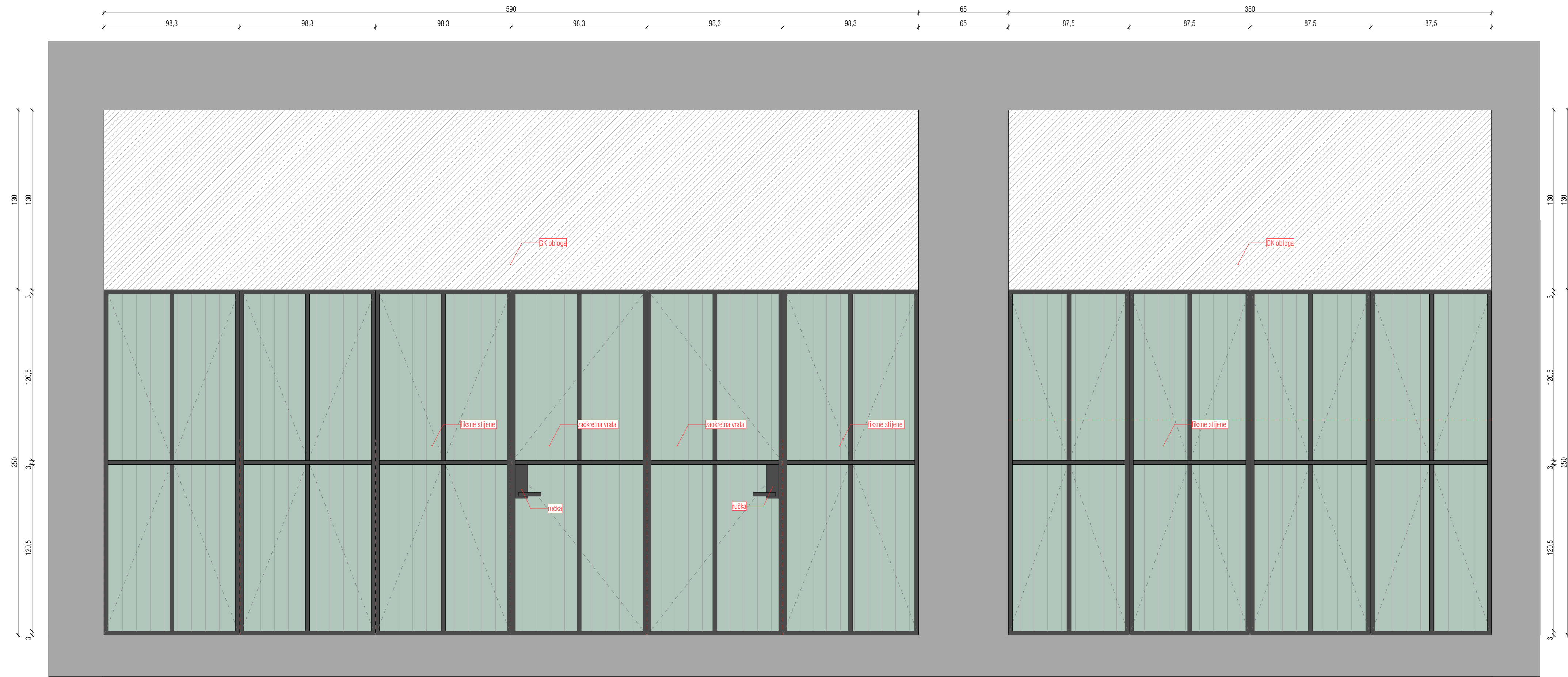
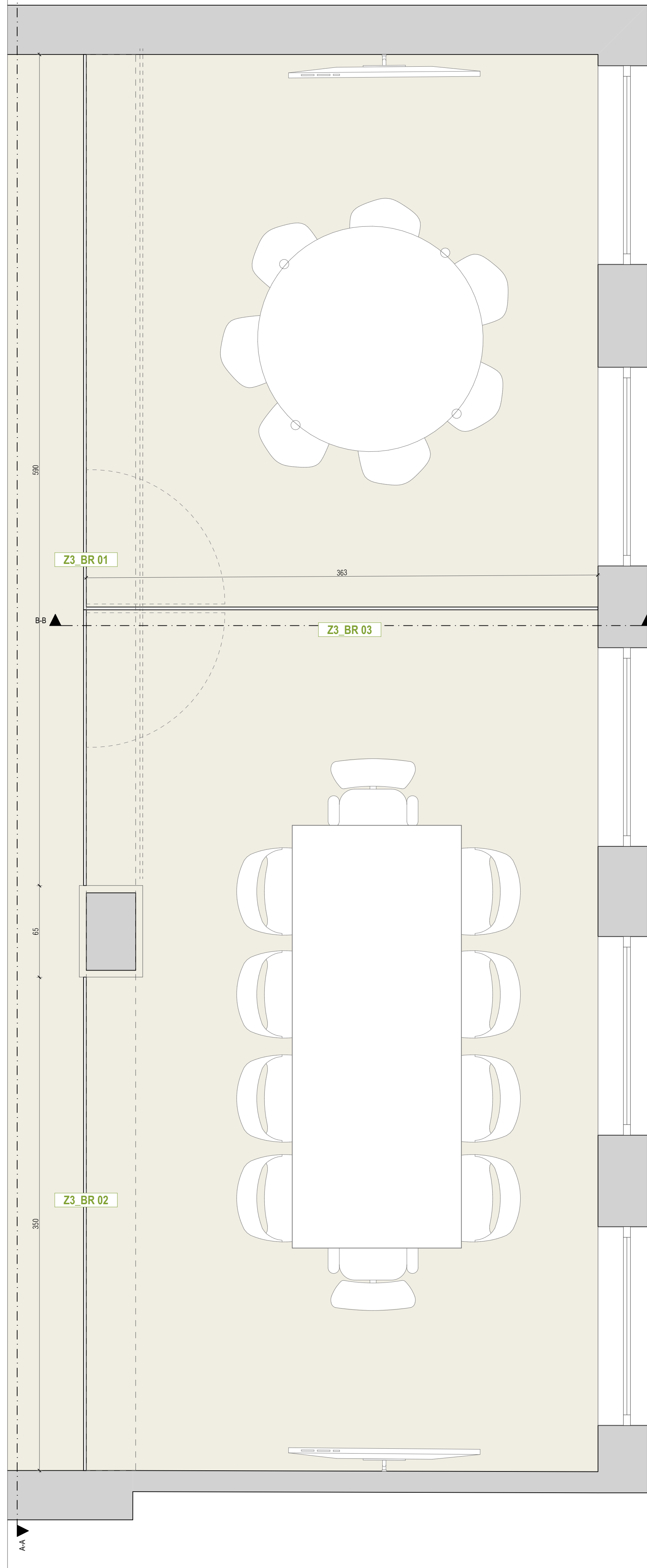

Z3\_BR 01 / BR 02

A-A

1:20

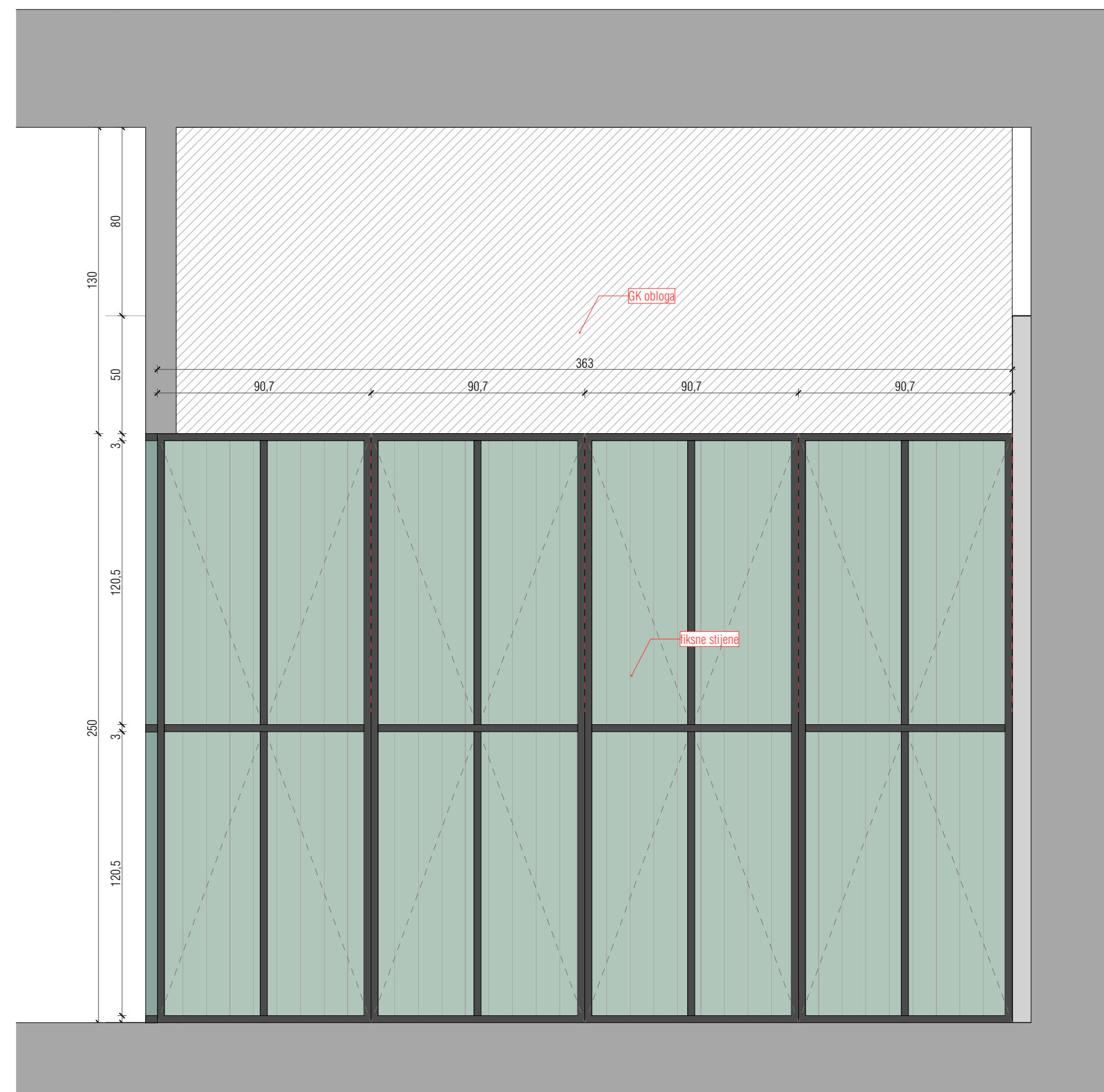

Z3\_BR 03

B-B

1:20

ZONA 8

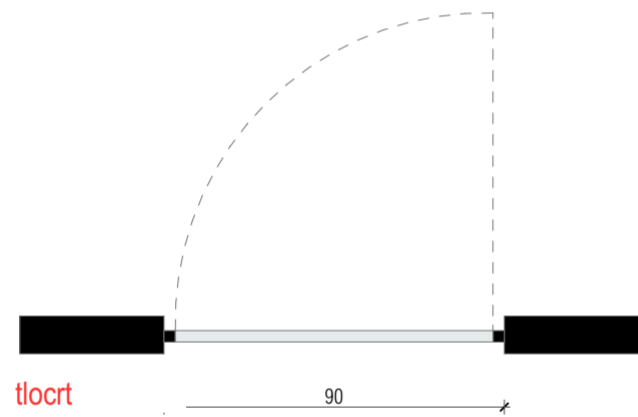
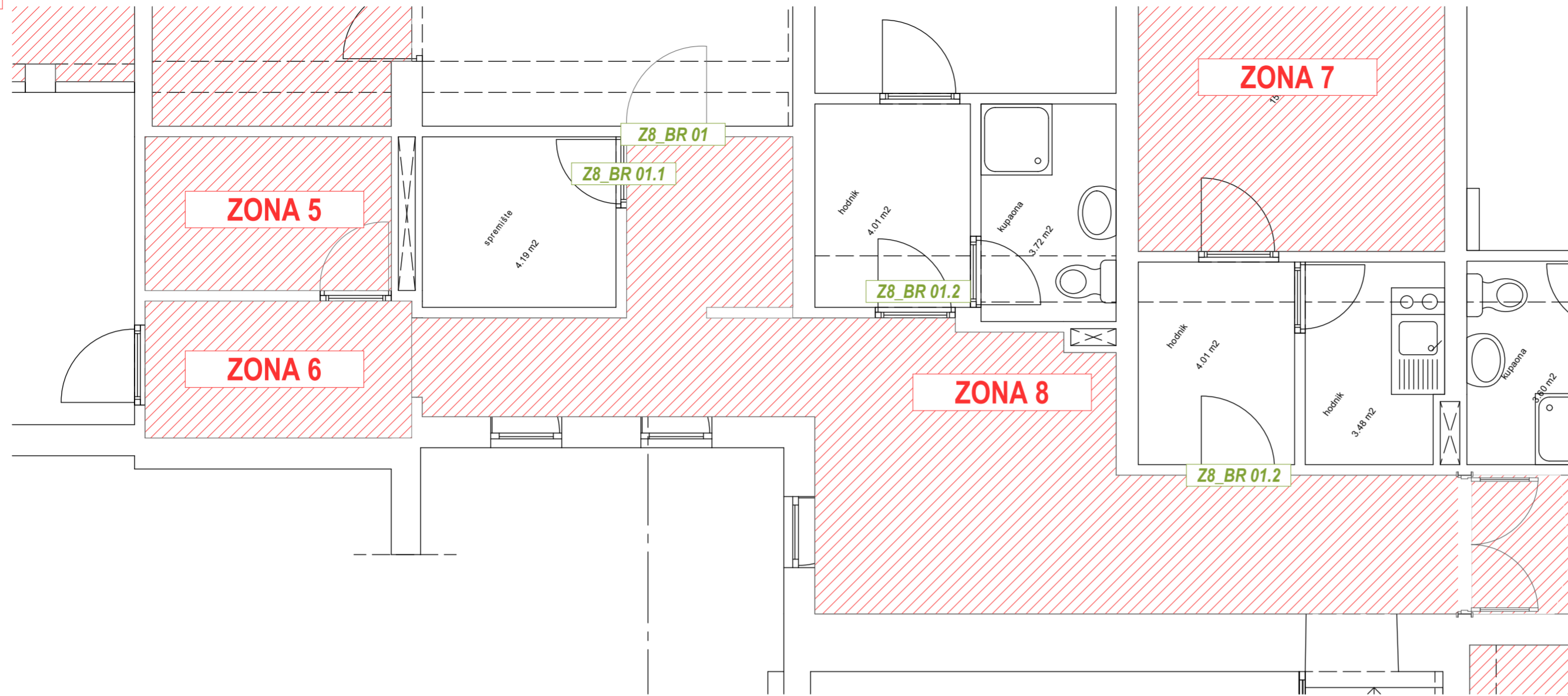

tlocrt

90

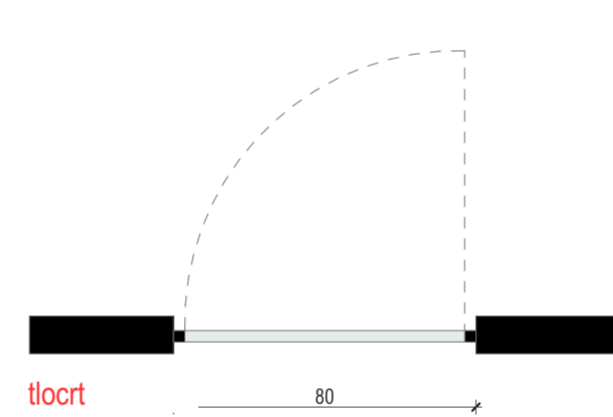

tlocrt

80

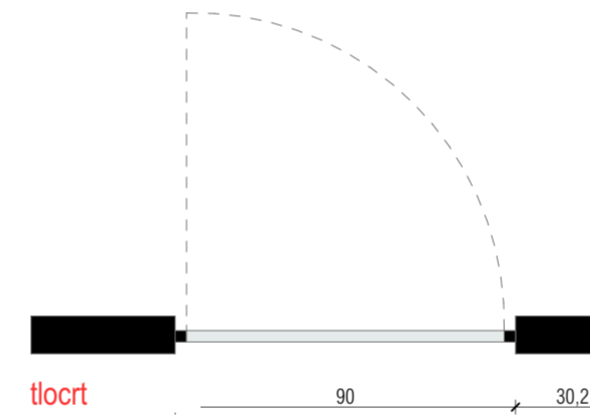

tlocrt

90

30.2

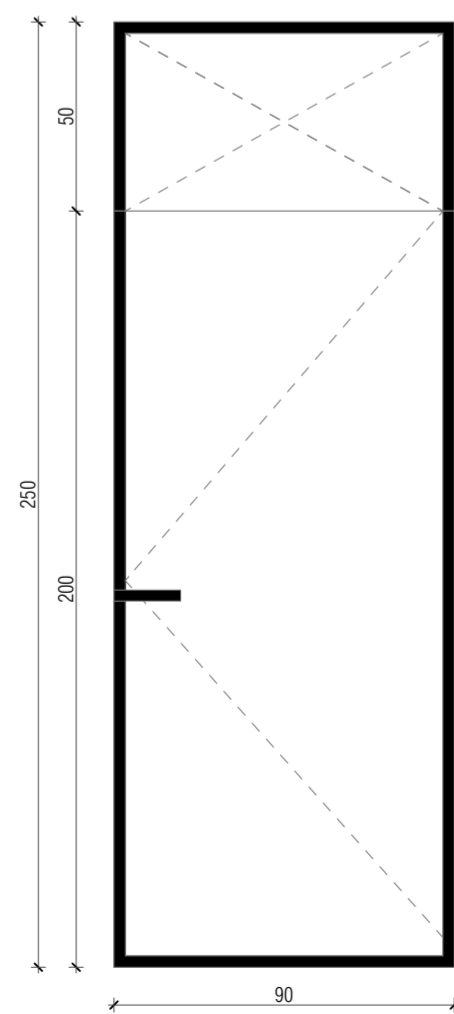
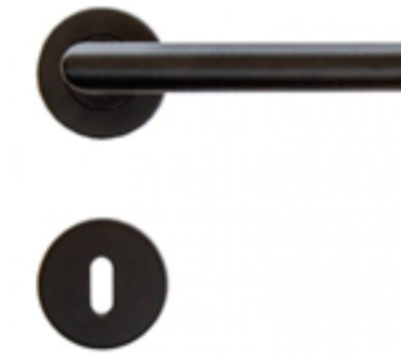

Z8\_BR 01

frontalni pogled

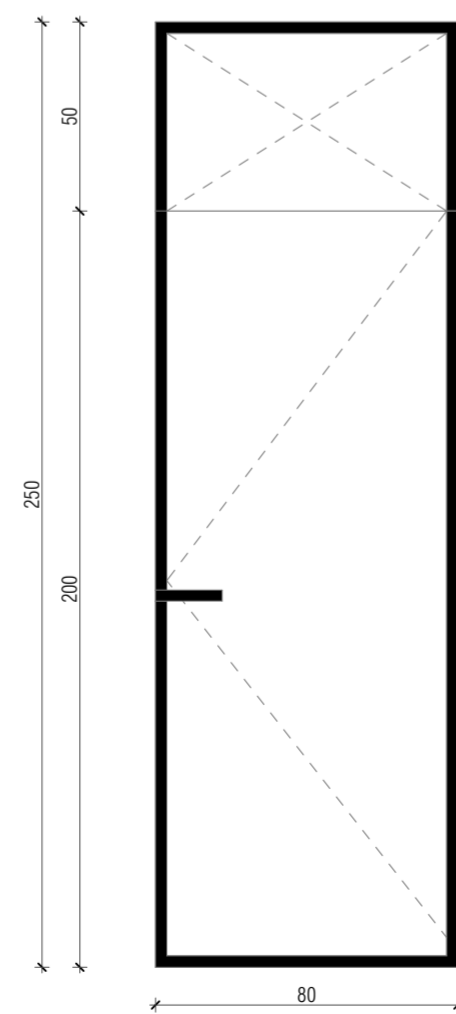

Z8\_BR 01.1

frontalni pogled

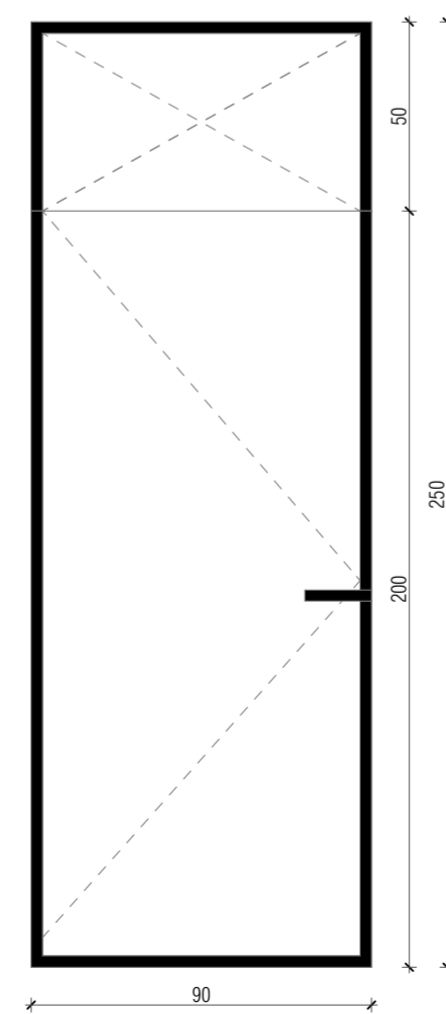

Z8\_BR 01.2

frontalni pogled

|   |                                 |                  |
|---|---------------------------------|------------------|
| <b>TISSA &amp; PARTNERS</b>   |                                 |                  |
| naziv građevine<br>1111_EMONIA  |                                 |                  |
| investitor<br>Aminess Novigrad  |                                 |                  |
| strukovna odrednica / naziv projekta<br>Interijer / Izvedbeni projekt | broj projekta<br>1111-02/25-IZI | datum<br>II/25   |
| projektant<br>ind. diz. Višen Slamar, Nina Štifanić mag. ing. arh.    |                                 |                  |
| sadržaj<br>Bravarija_ZONA_8   | mjerilo<br>1:20                 | list<br>1:50A.03 |

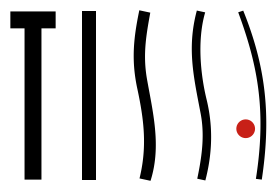

## B\_Podne obloge

### TISSA & PARTNERS

---

Rade Končara 1a, 52440 Poreč  
tissa@tissa.hr  
+385 52 431 552

[www.tissa.hr](http://www.tissa.hr)

---



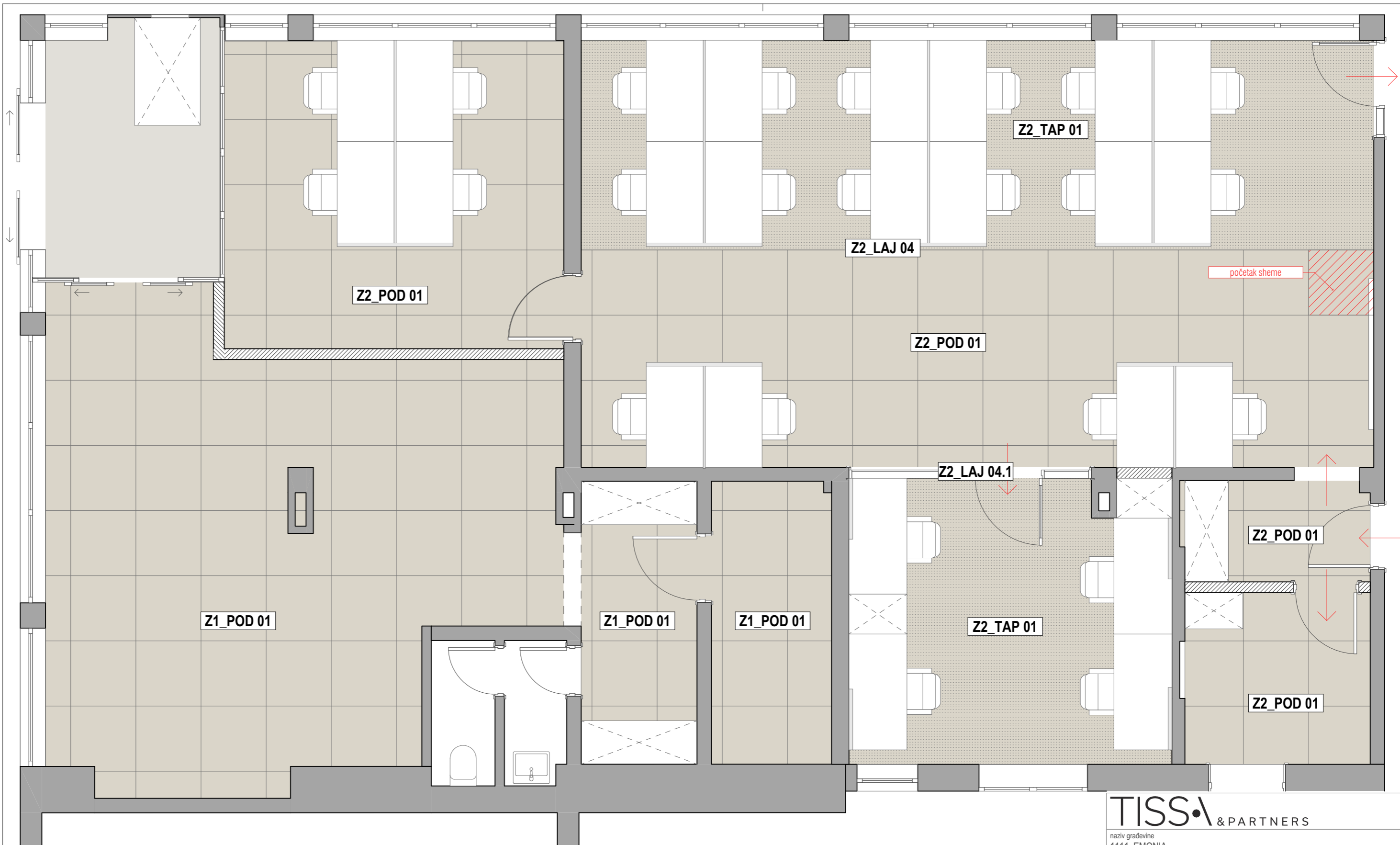

**ZONA 1** **ZONA 2**

**TISSA** & PARTNERS

naziv građevine  
1111\_EMONIA

investitor  
Aminess Novigrad

strukovna odrednica / naziv projekta  
Interijer / Izvedbeni projekt

broj projekta  
1111-02/25-IZI

datum  
II/25

projektant  
ind. diz. Višen Slamar, Nina Štifić mag. ing. arh.

sadržaj  
Podne obloge\_ZONA\_1 i ZONA\_2

mjerilo  
1:50

list  
B.01

**ZONA 5**

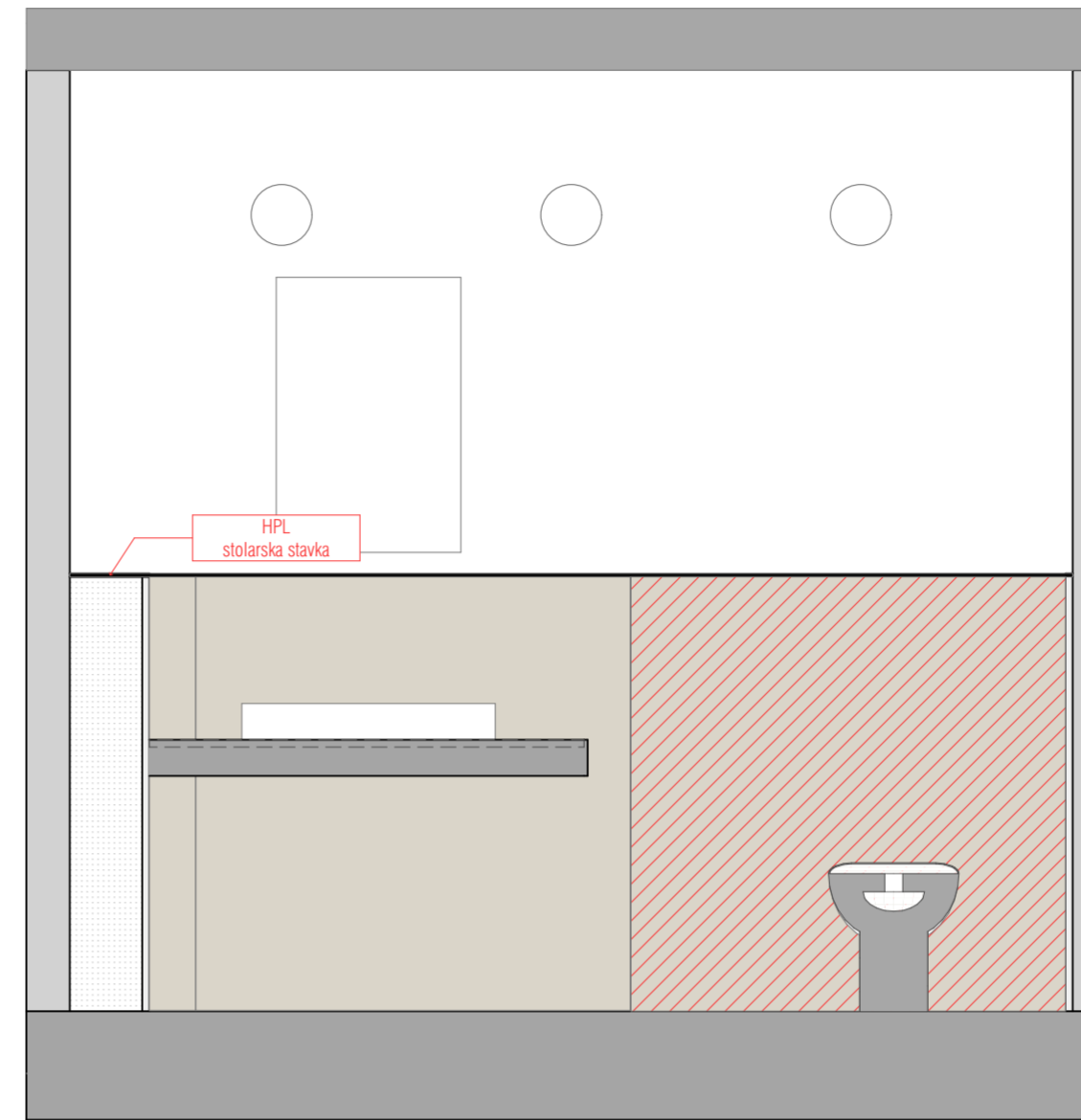
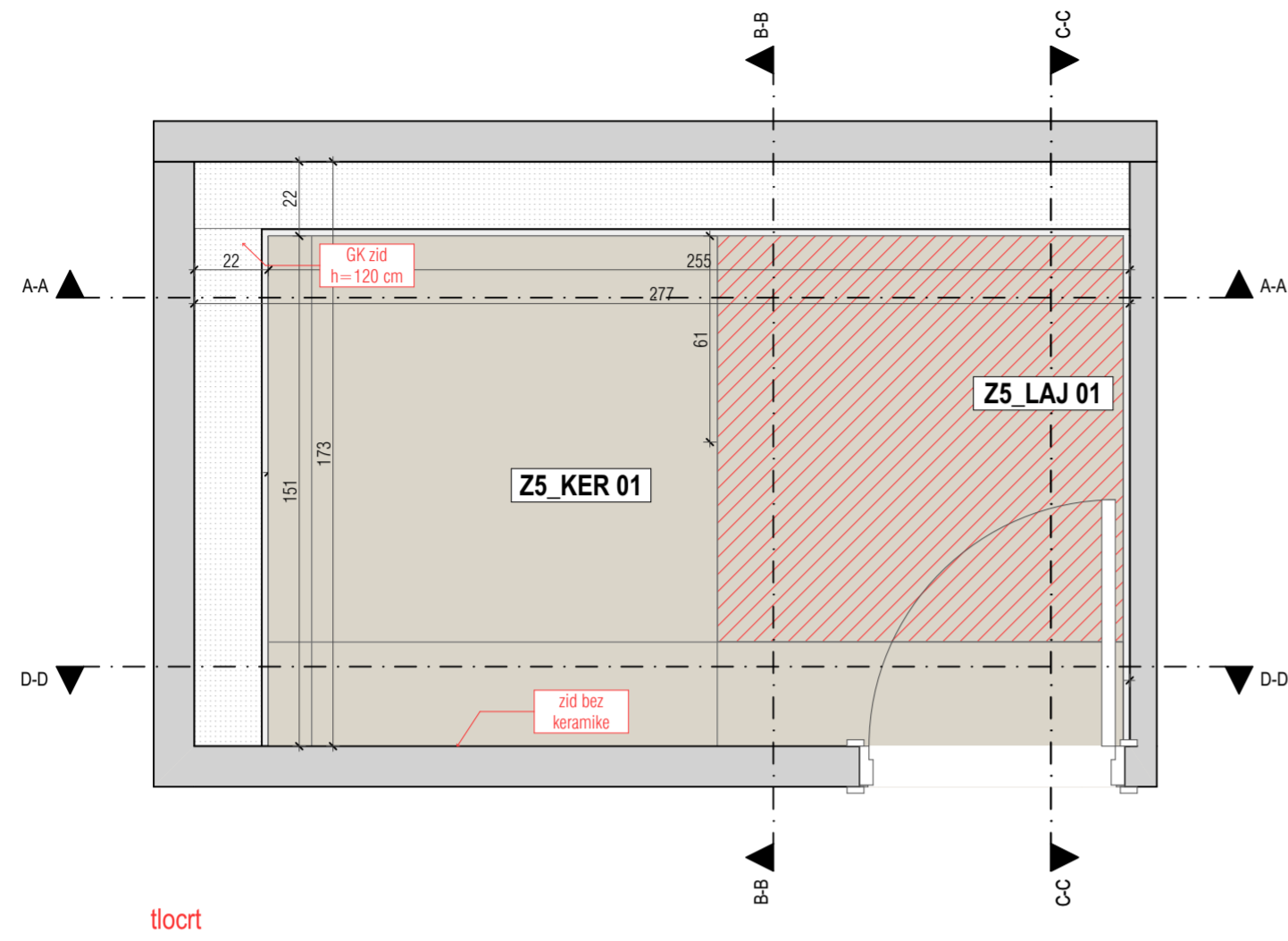

ZONA 5 A-A 1:20

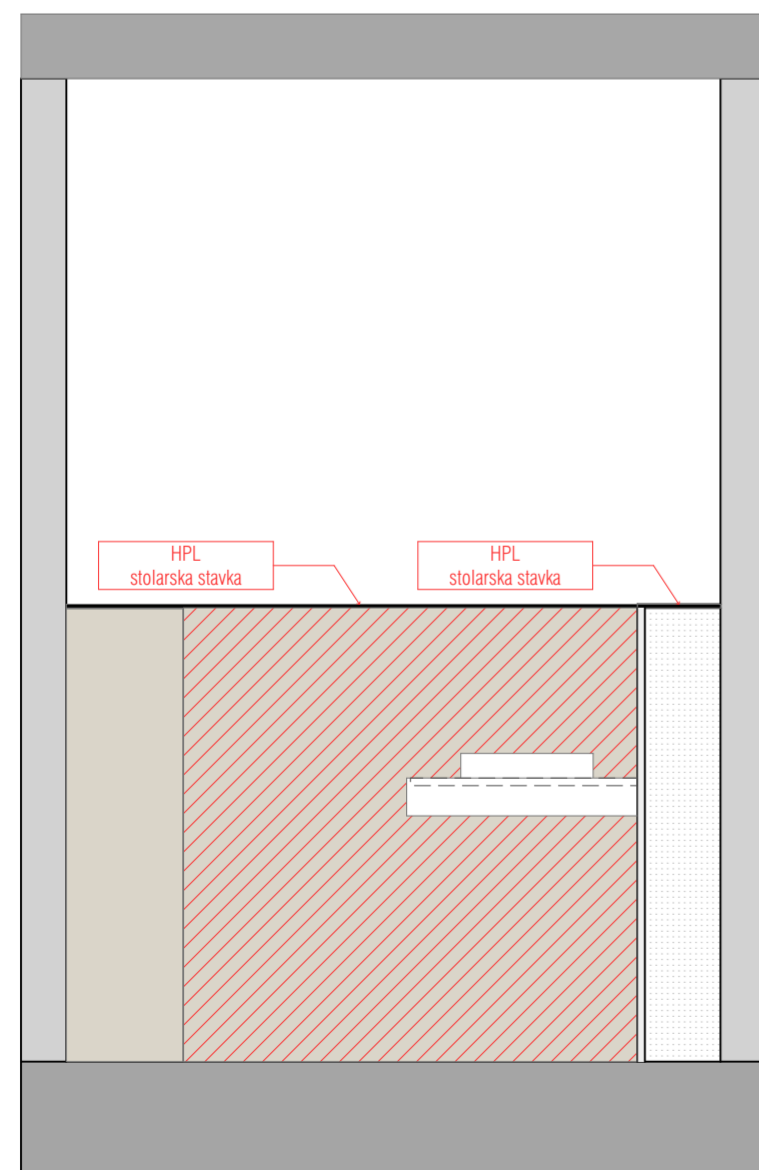

ZONA 5 B-B 1:20

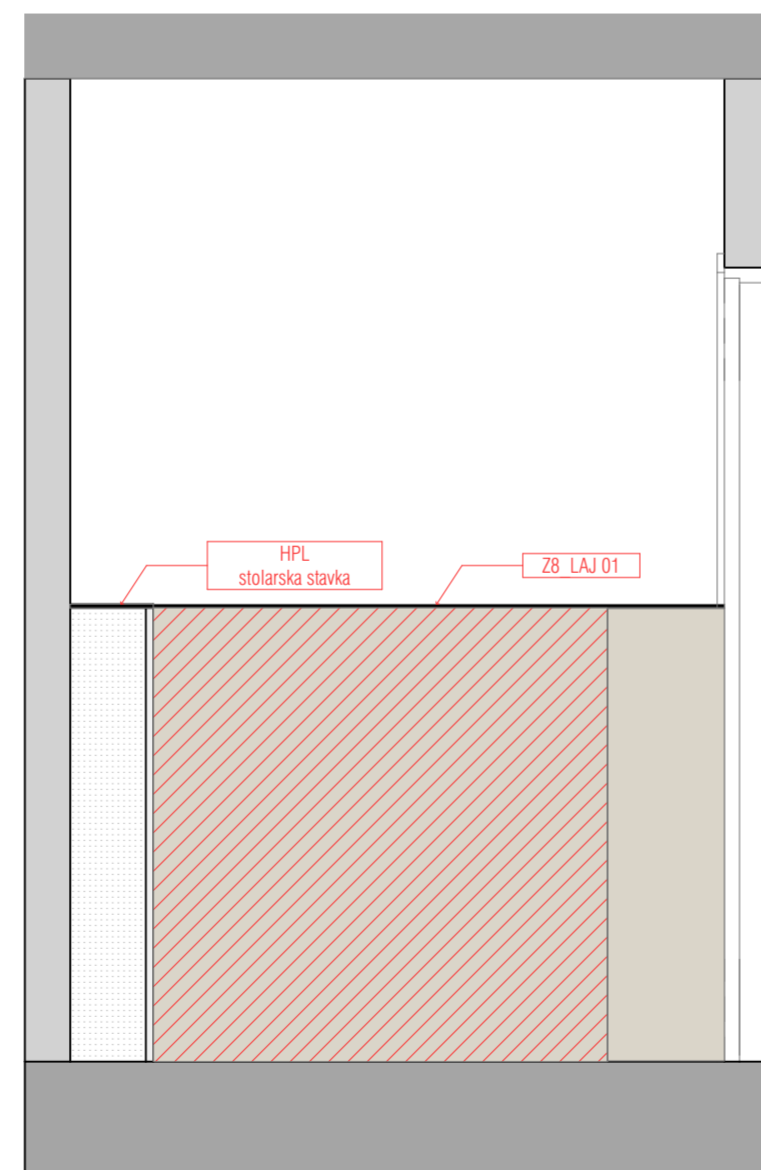

ZONA 5 C-C 1:20

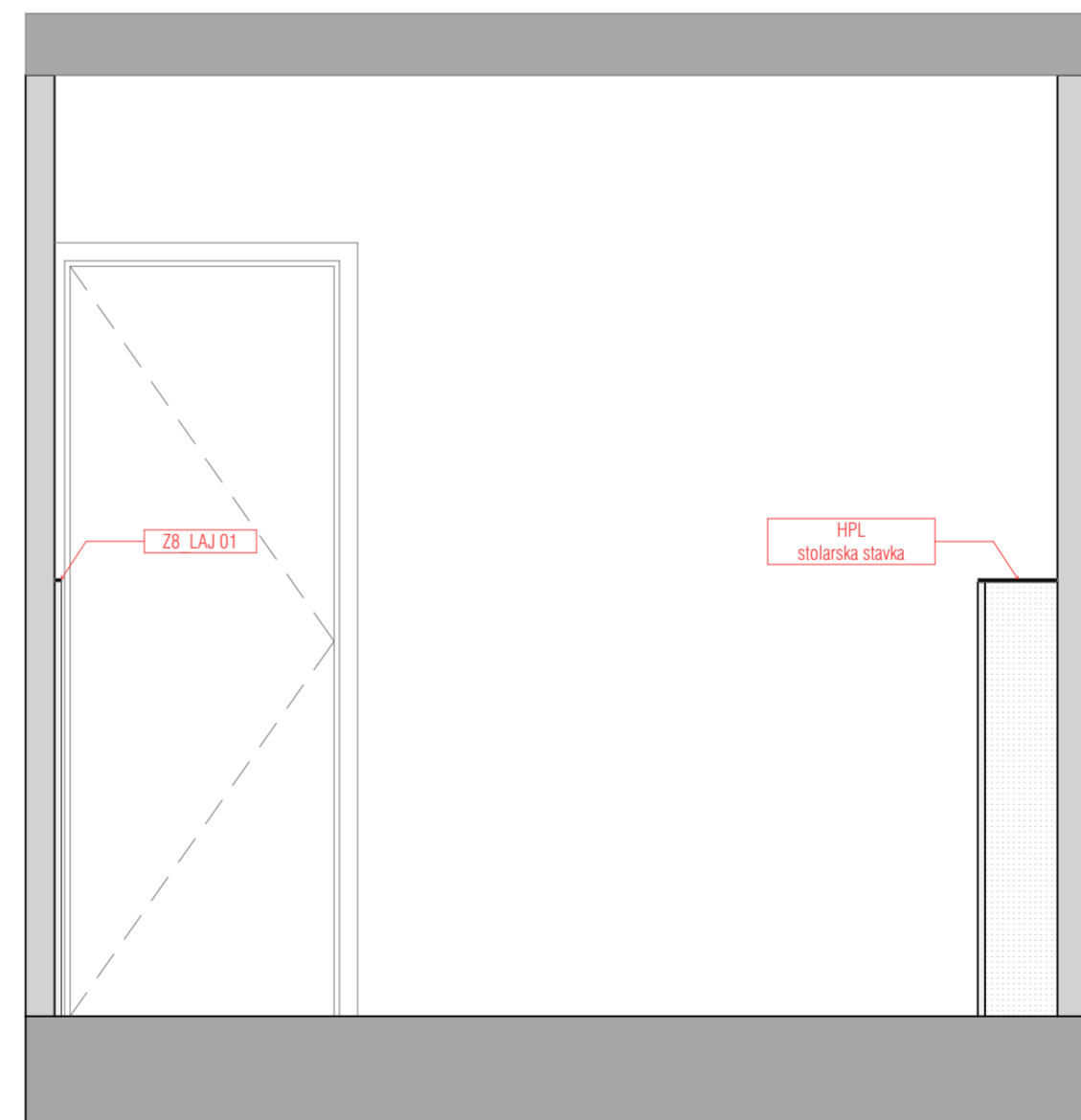

ZONA 5 D-D 1:20

|   |                                 |                |
|---|---------------------------------|----------------|
| <b>TISSA &amp; PARTNERS</b>   |                                 |                |
| naziv građevine<br>1111_EMONIA  |                                 |                |
| investitor<br>Amines Novigrad   |                                 |                |
| strukovna odrednica / naziv projekta<br>Interijer / Izvedbeni projekt | broj projekta<br>1111-02/25-IZI | datum<br>II/25 |
| projektant<br>ind. diz. Višen Slamar, Nina Štifanić mag. ing. arh.    |                                 |                |
| sadržaj<br>Podne obloge_ZONA_5  | mjerilo<br>1:20                 | list<br>B.02   |

**ZONA 9**

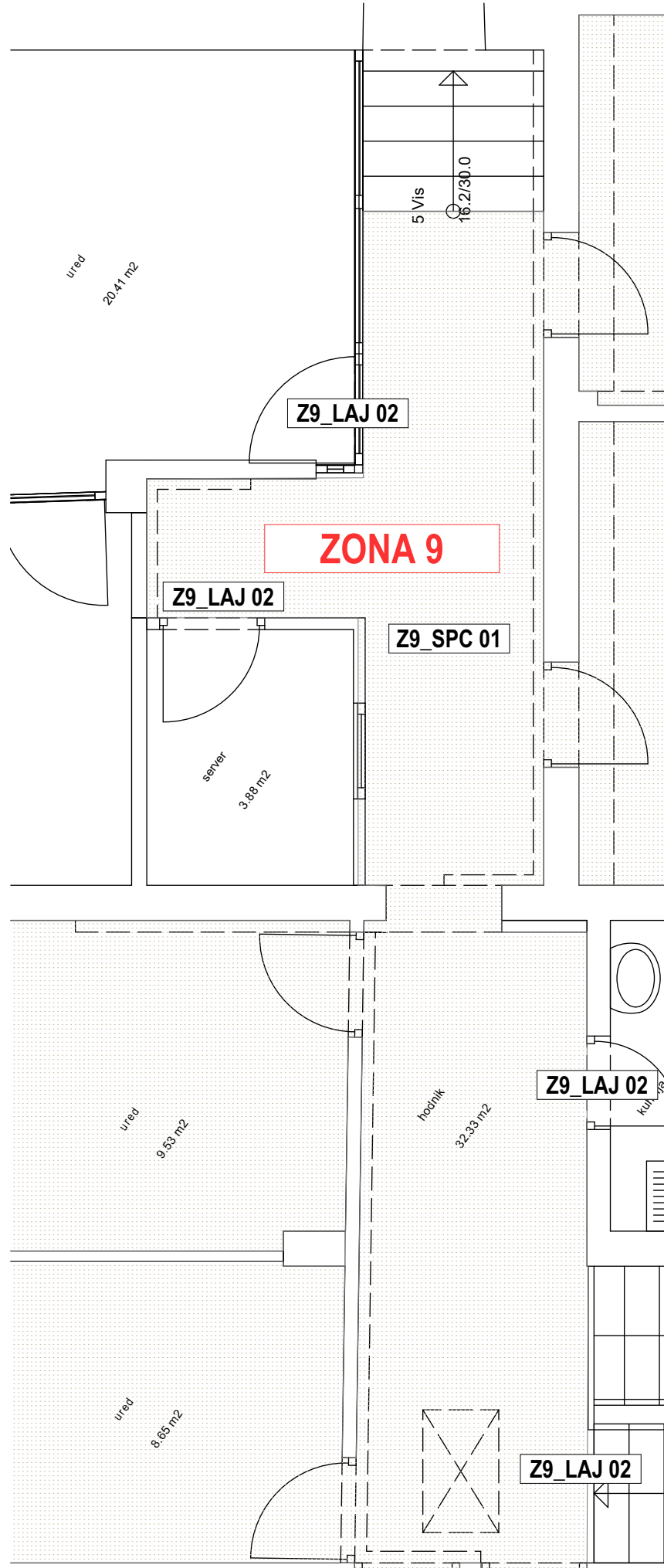

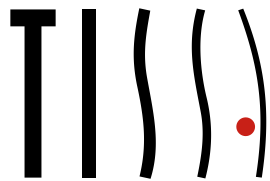

## C\_Kupovna oprema

### TISSA & PARTNERS

---

Rade Končara 1a, 52440 Poreč  
tissa@tissa.hr  
+385 52 431 552

[www.tissa.hr](http://www.tissa.hr)

---



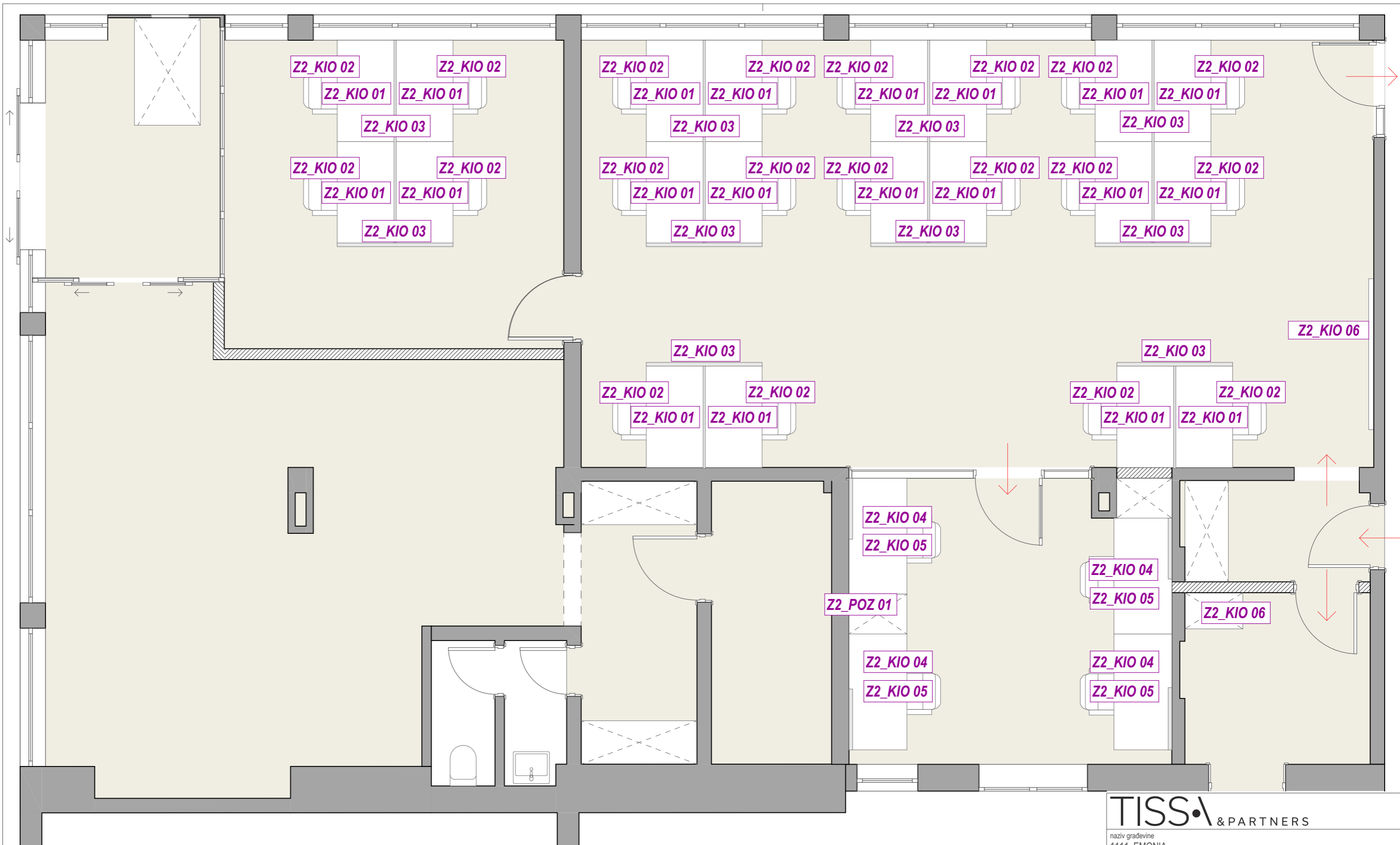

**ZONA 1** **ZONA 2**

**TISSA** & PARTNERS

naziv građevine  
1111\_EMONIA

investitor  
Aminess Novigrad

strukovna odrednica / naziv projekta  
Interijer / Izvedbeni projekt

broj projekta  
1111-02/25-IZI

datum  
II/25

projektant  
ind. diz. Višen Slamar, Nina Štifanić mag. ing. arh.

sadržaj  
Kupovna oprema\_ZONA\_1 i ZONA\_2

mjerilo  
1:50

list  
C.01

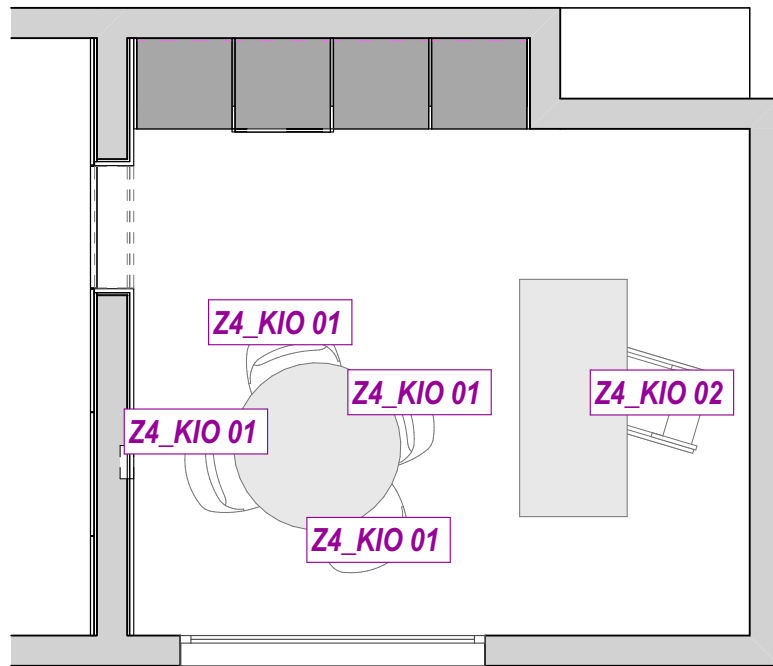
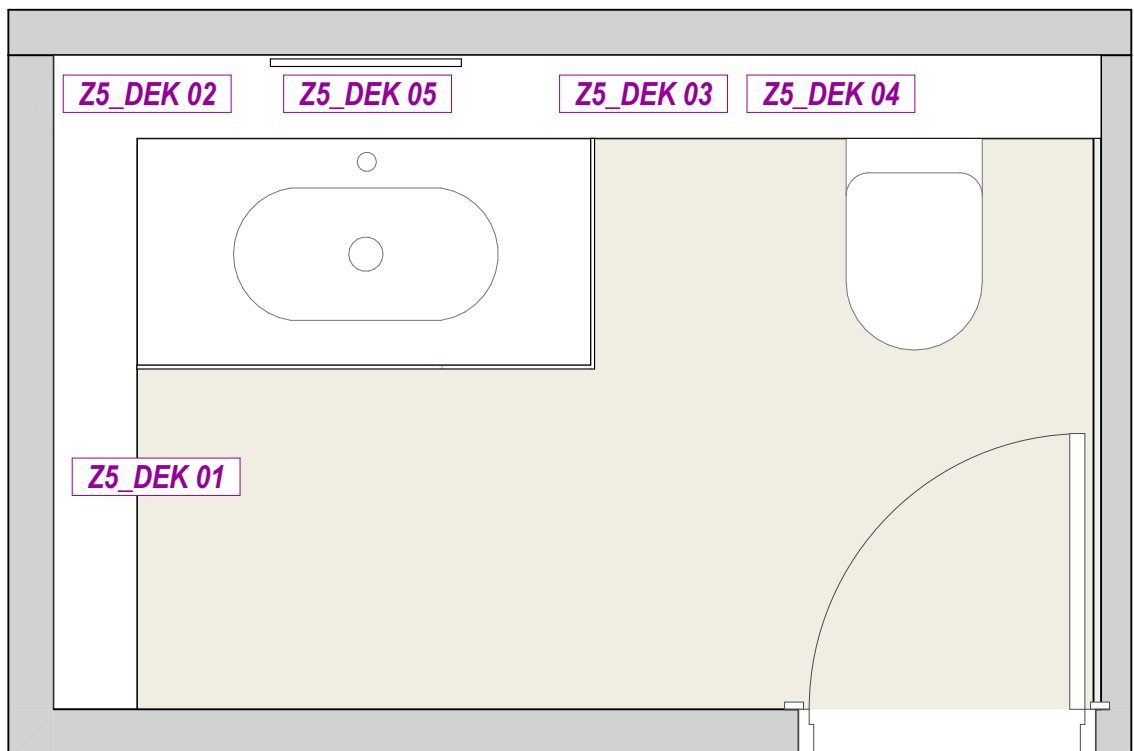
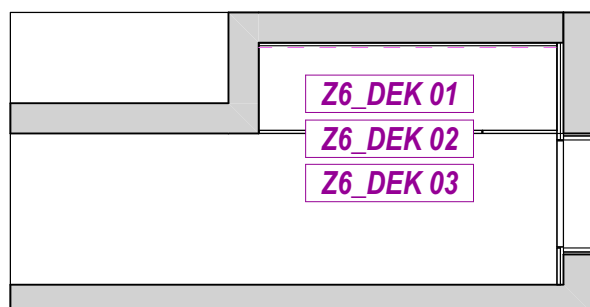
**ZONA 4****ZONA 5****ZONA 6**

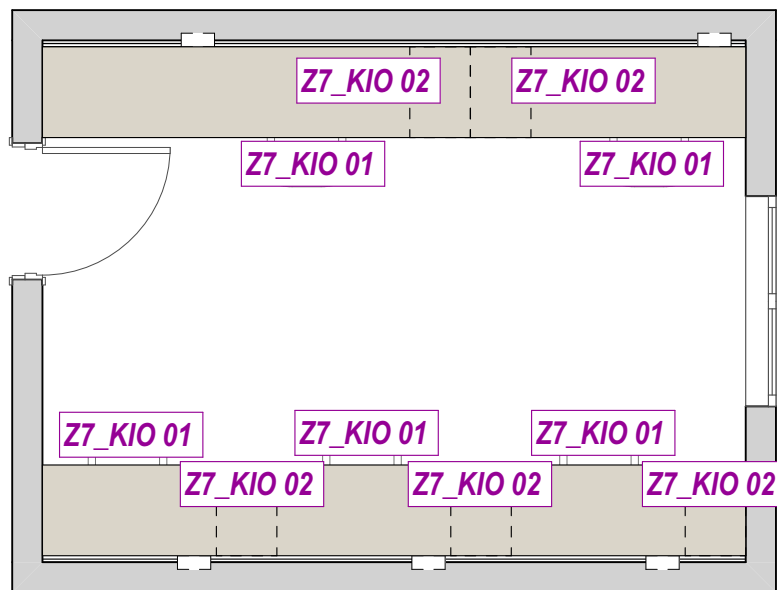
**ZONA 7**

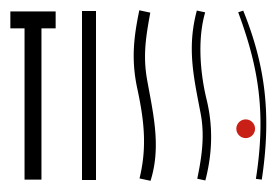

## D\_Oprema po mjeri

### TISSA & PARTNERS

---

Rade Končara 1a, 52440 Poreč  
tissa@tissa.hr  
+385 52 431 552

[www.tissa.hr](http://www.tissa.hr)

---





**ZONA 1** **ZONA 2**

**TISSA** & PARTNERS

naziv građevine  
1111\_EMONIA

investitor  
Aminess Novigrad

strukovna odrednica / naziv projekta  
Interijer / Izvedbeni projekt

broj projekta  
1111-02/25-IZI

datum  
II/25

projektant  
ind. diz. Višen Slamar, Nina Štifić mag. ing. arh.

sadržaj  
Oprema po mjeri\_ZONA\_1 i ZONA\_2

mjerilo  
1:50

list  
D.01





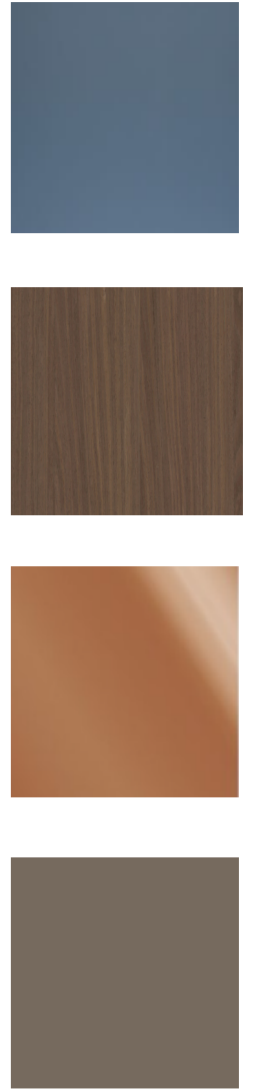

|   |                                 |                |
|---|---------------------------------|----------------|
| <b>TISSA &amp; PARTNERS</b>   |                                 |                |
| naziv građevine<br>1111_EMONIA  |                                 |                |
| investitor<br>Aminess Novigrad  |                                 |                |
| strukovna odrednica / naziv projekta<br>Interijer / Izvedbeni projekt | broj projekta<br>1111-02/25-IZI | datum<br>II/25 |
| projektant<br>ind. diz. Višen Slamar, Nina Štifanić mag. ing. arh.    |                                 |                |
| sadržaj<br>Oprema po mjeri_ZONA_4                                     | mjerilo                         | list<br>D.04   |

**ZONA 5**

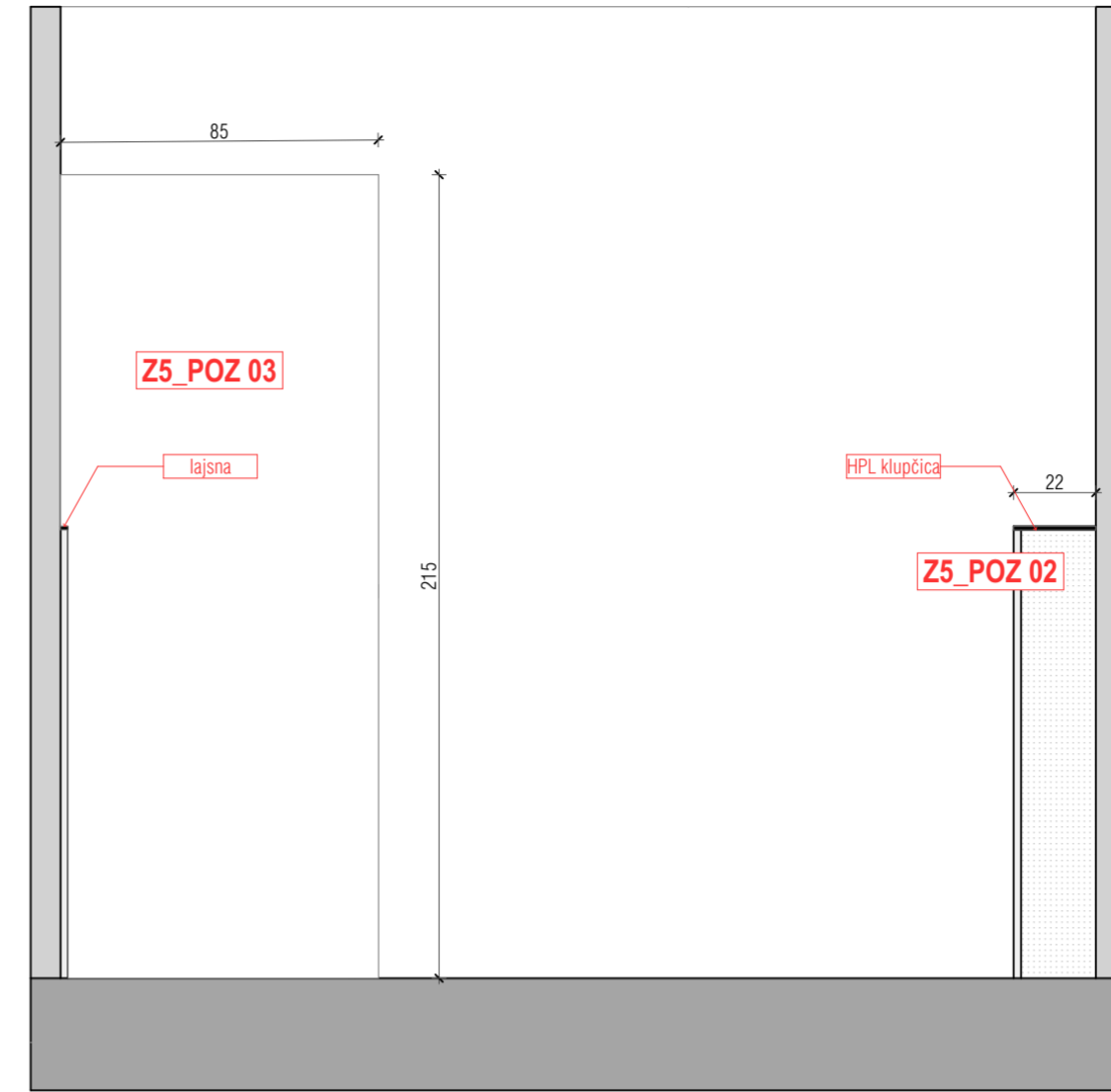
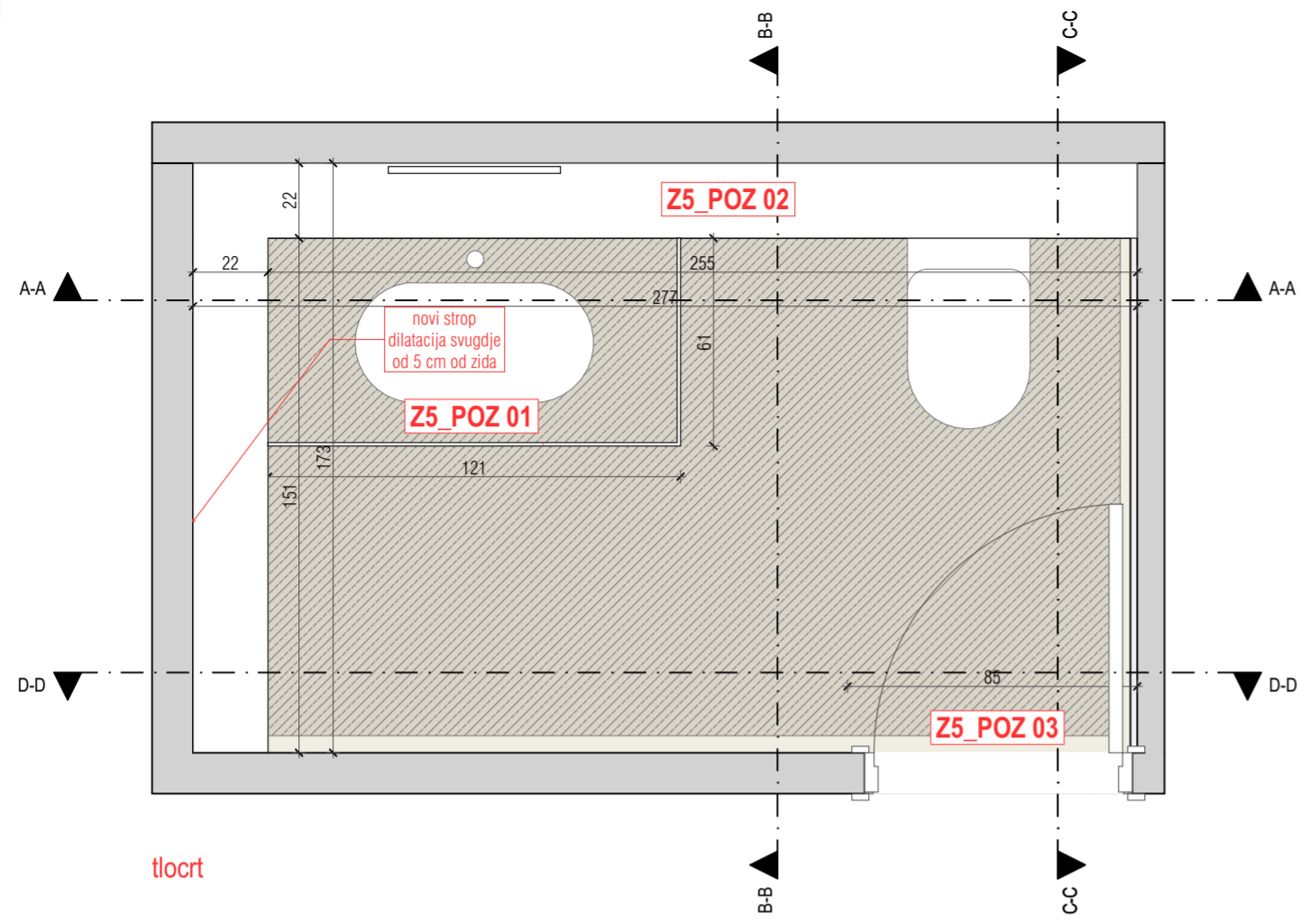

ZONA 5 D-D 1:20

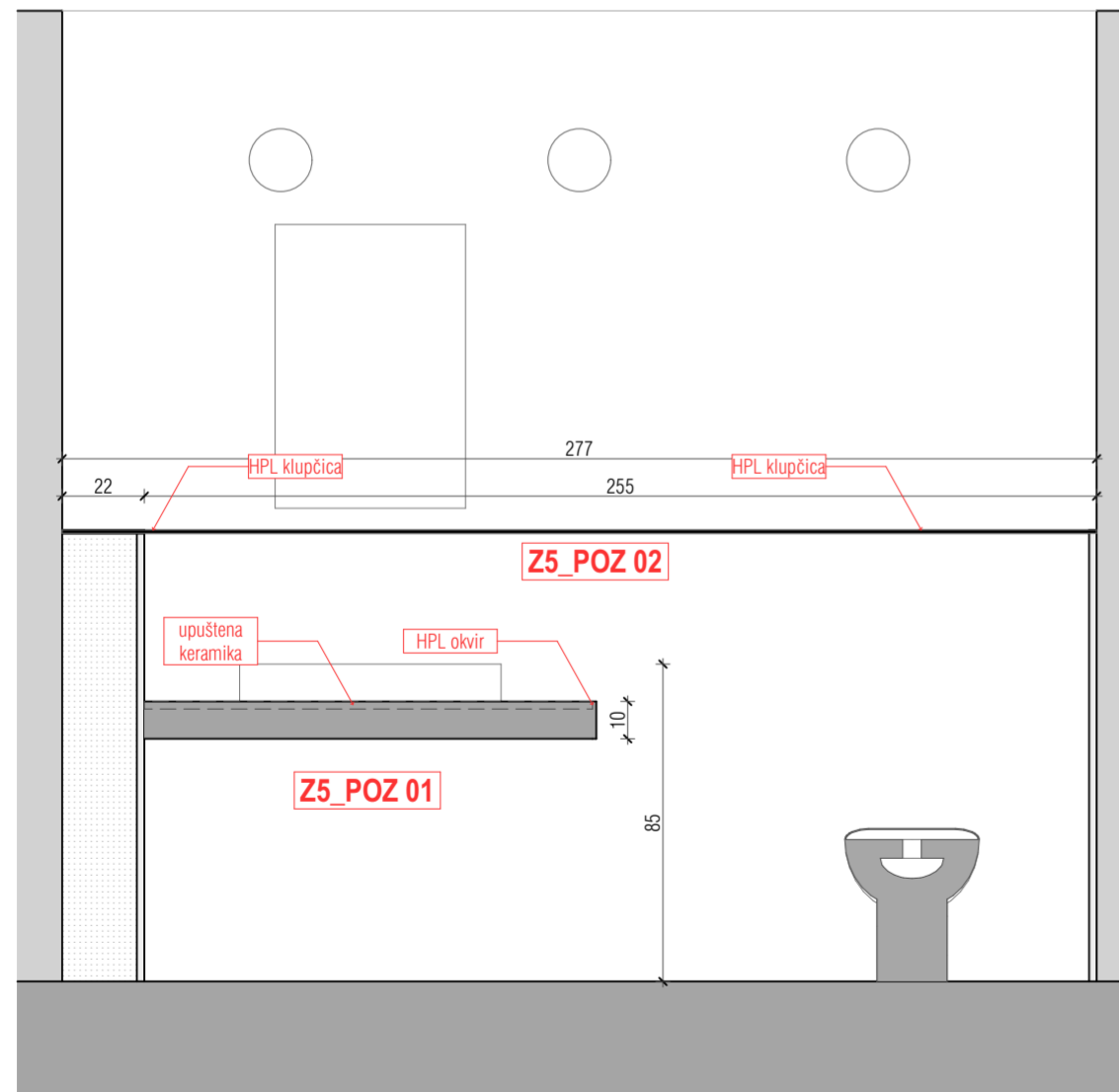

ZONA 5 A-A 1:20

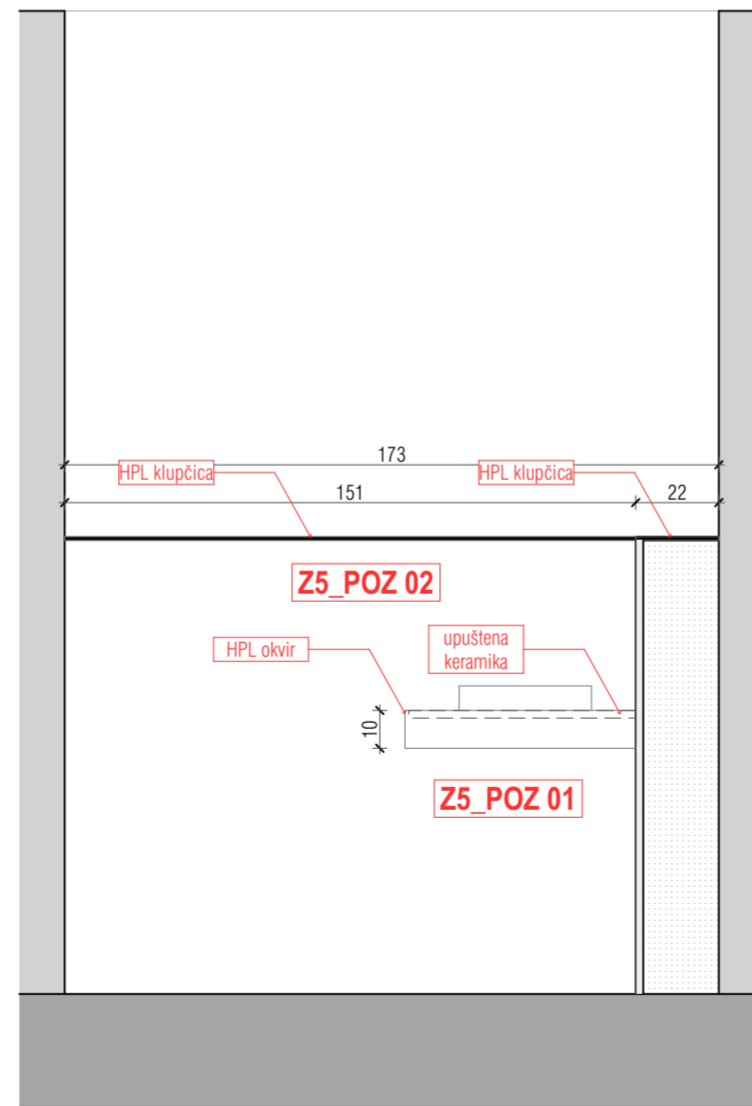

ZONA 5 B-B 1:20

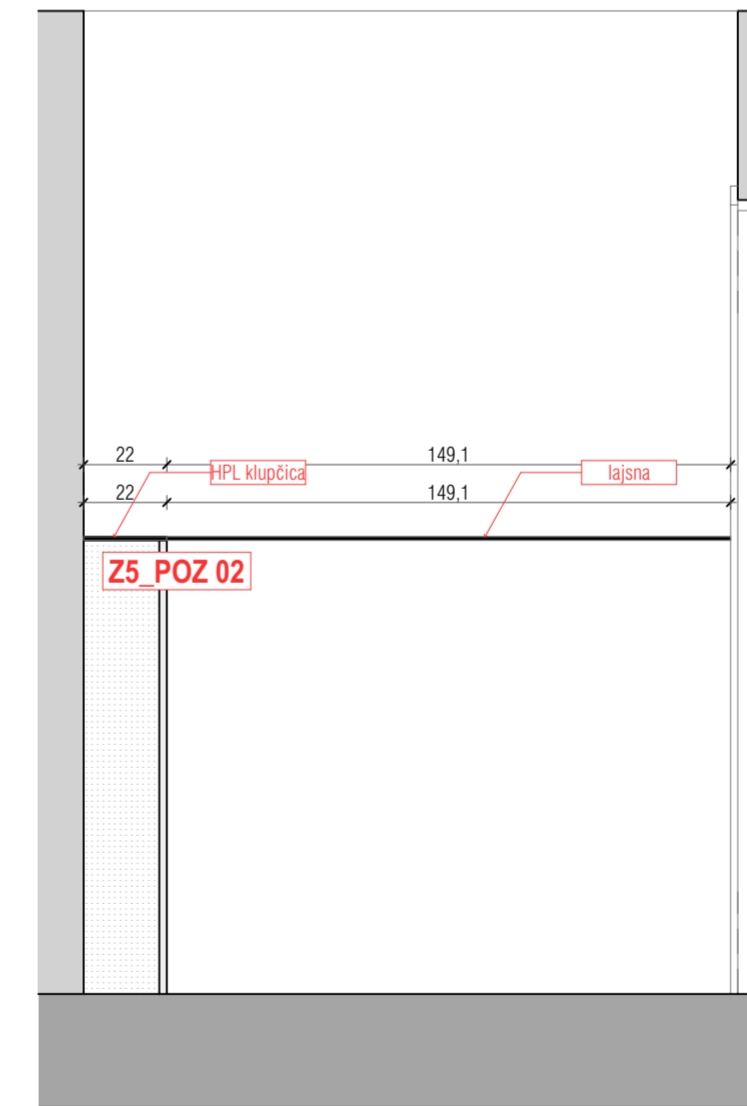

ZONA 5 C-C 1:20

|   |                                 |                |
|---|---------------------------------|----------------|
| <b>TISSA &amp; PARTNERS</b>   |                                 |                |
| naziv građevine<br>1111_EMONIA  |                                 |                |
| investitor<br>Aminess Novigrad  |                                 |                |
| strukovna odrednica / naziv projekta<br>Interijer / Izvedbeni projekt | broj projekta<br>1111-02/25-IZI | datum<br>II/25 |
| projektant<br>ind. diz. Višen Slamar, Nina Štifanić mag. ing. arh.    |                                 |                |
| sadržaj<br>Oprema po mjeri_ZONA_5                                     | mjerilo<br>1:20                 | list<br>D.05   |

**ZONA 6**

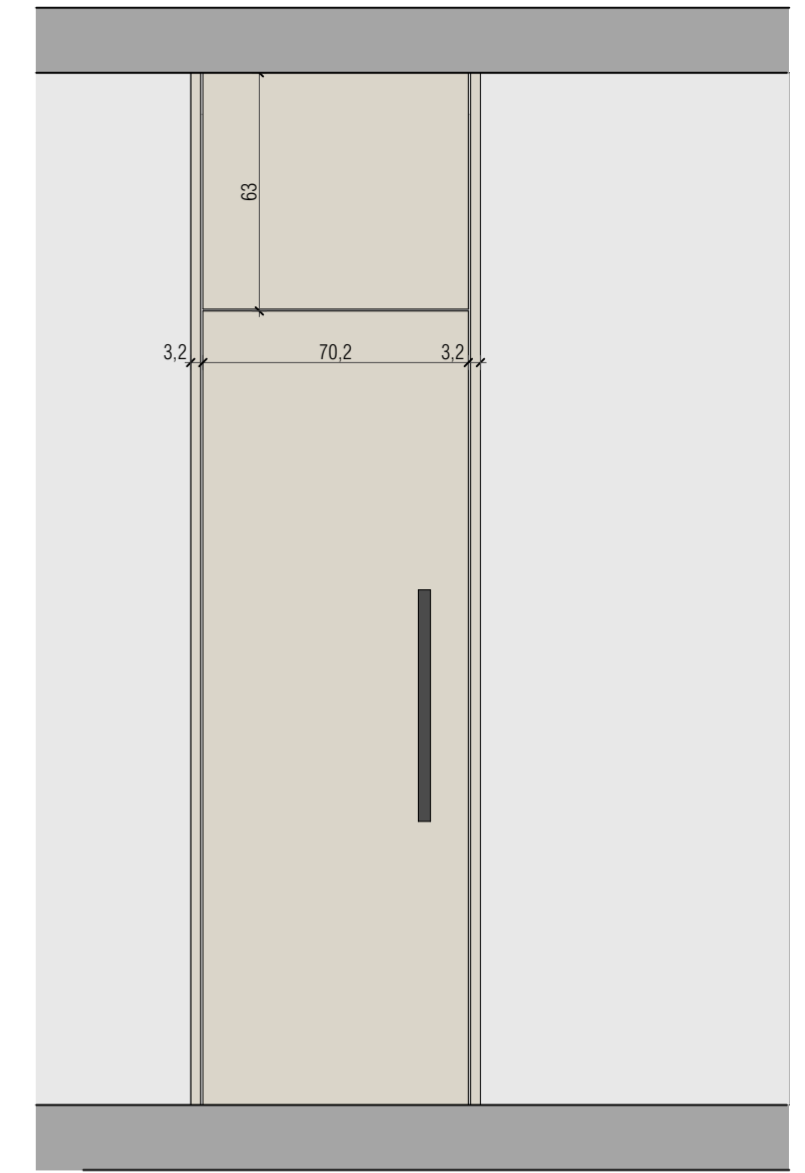
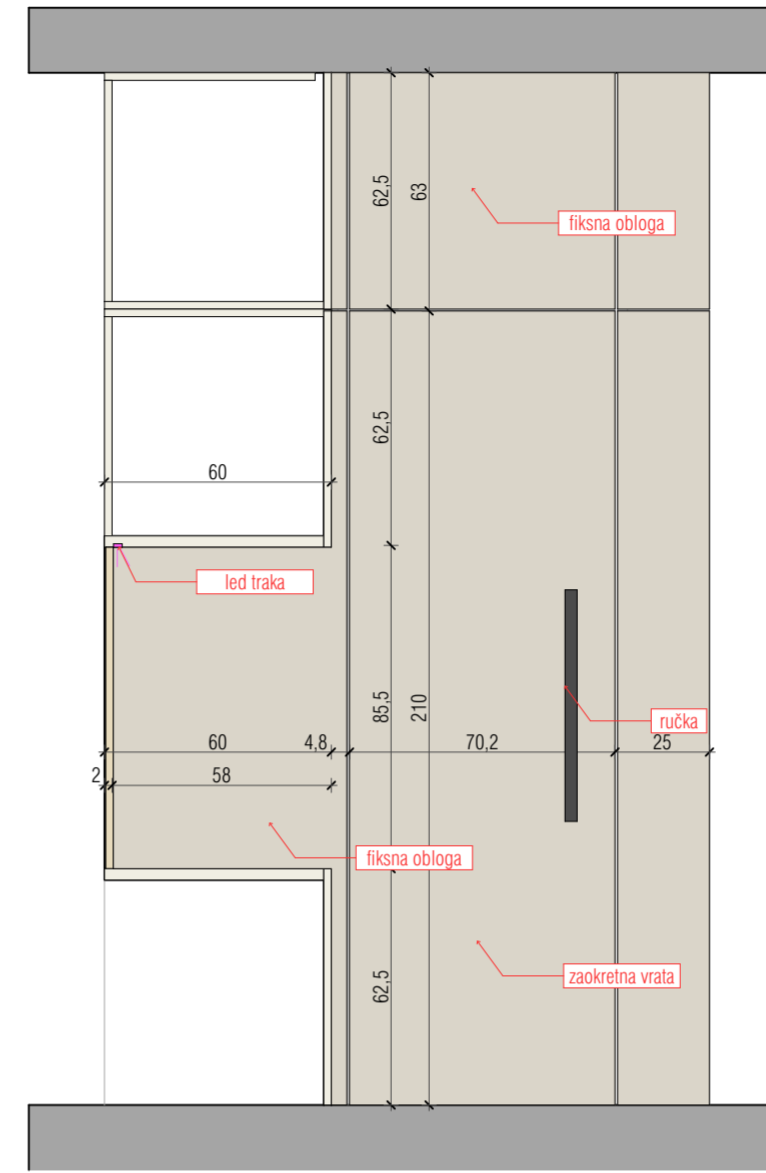
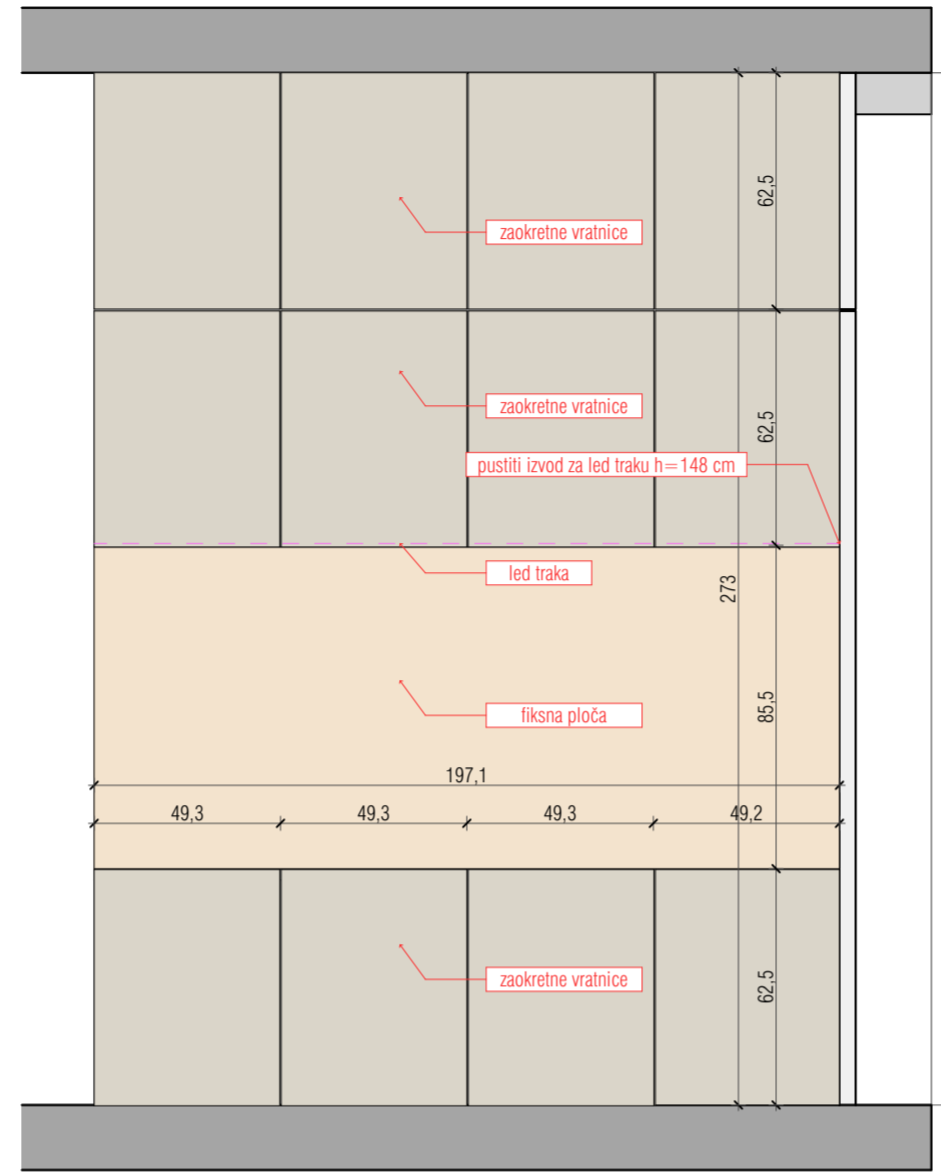
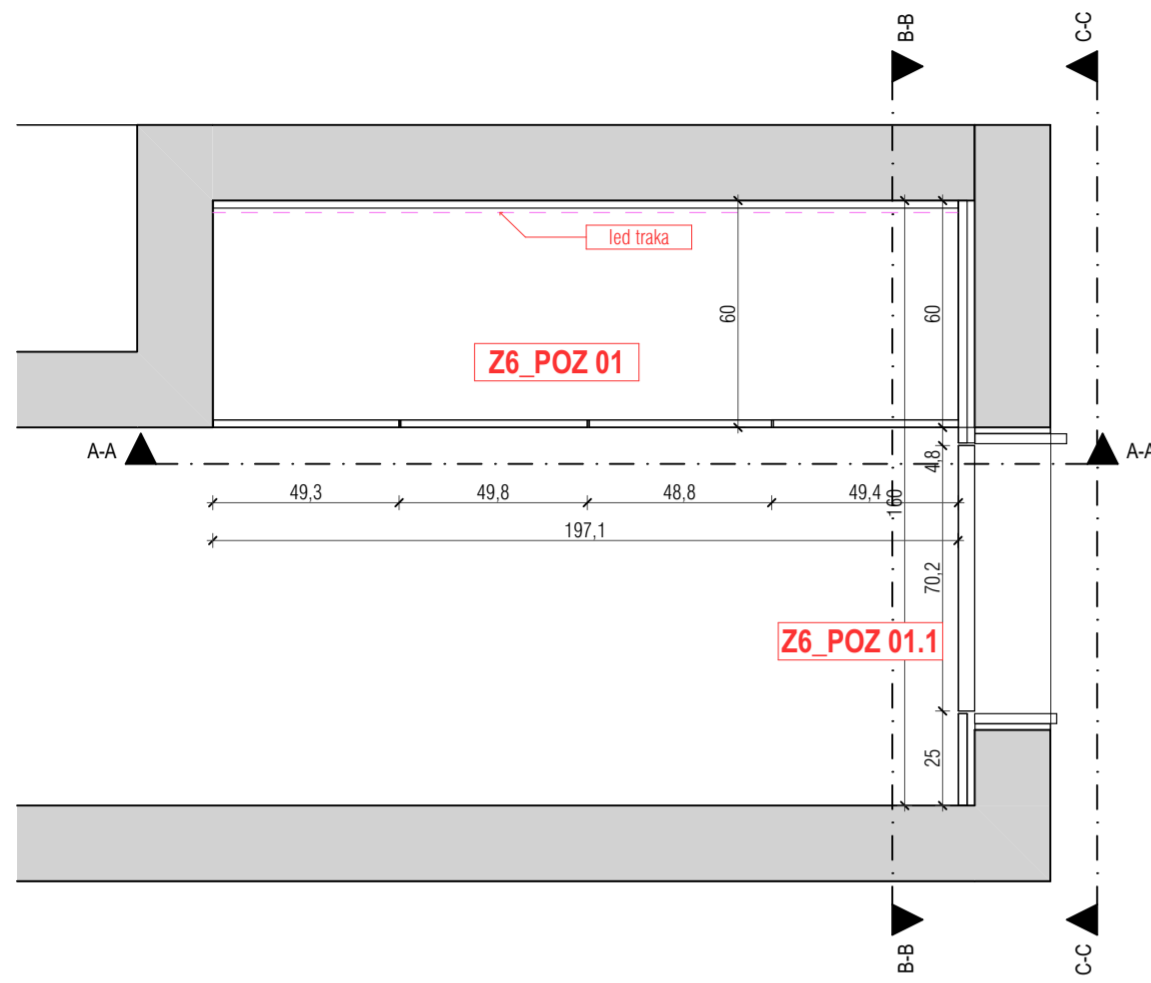

Z6\_POZ 01 A-A 1:20

Z6\_POZ 01 / Z6\_POZ 01.1 B-B 1:20

Z6\_POZ 01.1 C-C 1:20



|   |                                 |                |
|---|---------------------------------|----------------|
| <b>TISSA &amp; PARTNERS</b>   |                                 |                |
| naziv građevine<br>1111_EMONIA  |                                 |                |
| investitor<br>Amines Novigrad   |                                 |                |
| strukovna odrednica / naziv projekta<br>Interijer / Izvedbeni projekt | broj projekta<br>1111-02/25-IZI | datum<br>II/25 |
| projektant<br>ind. diz. Višen Slamar, Nina Štifanić mag. ing. arh.    |                                 |                |
| sadržaj<br>Oprema po mjeri_ZONA_6                                     | mjerilo<br>1:20                 | list<br>D.06   |

**ZONA 7**

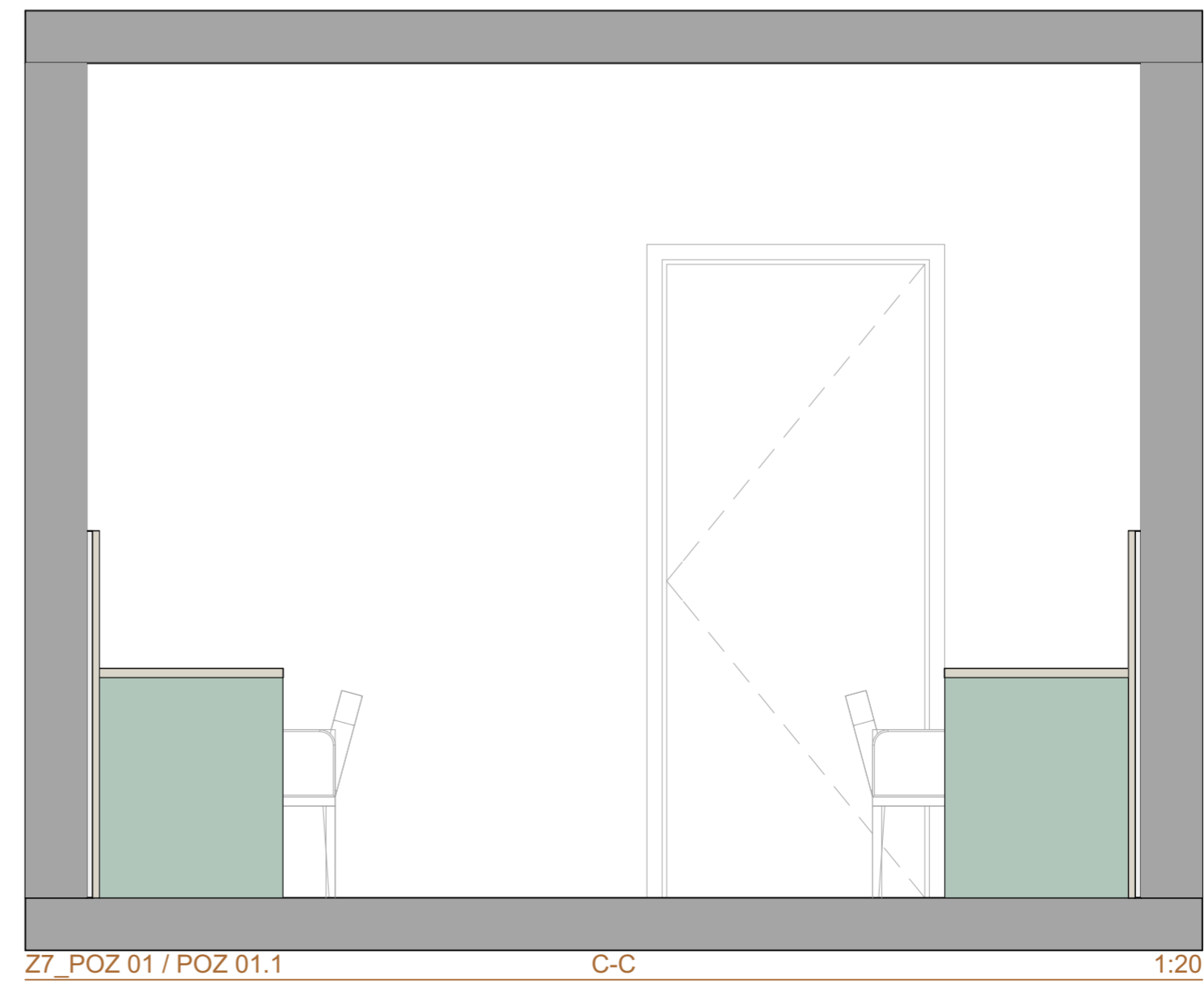
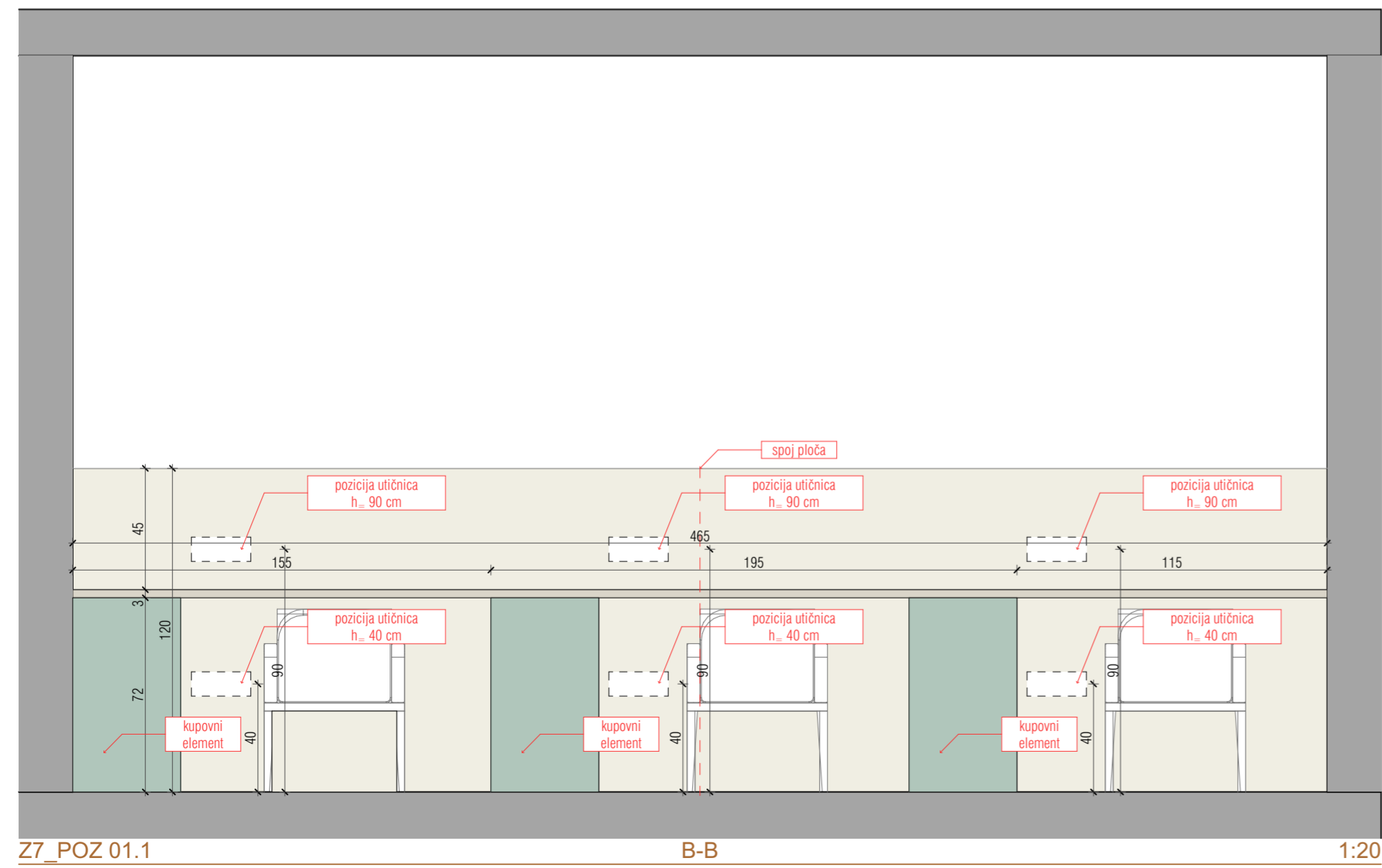
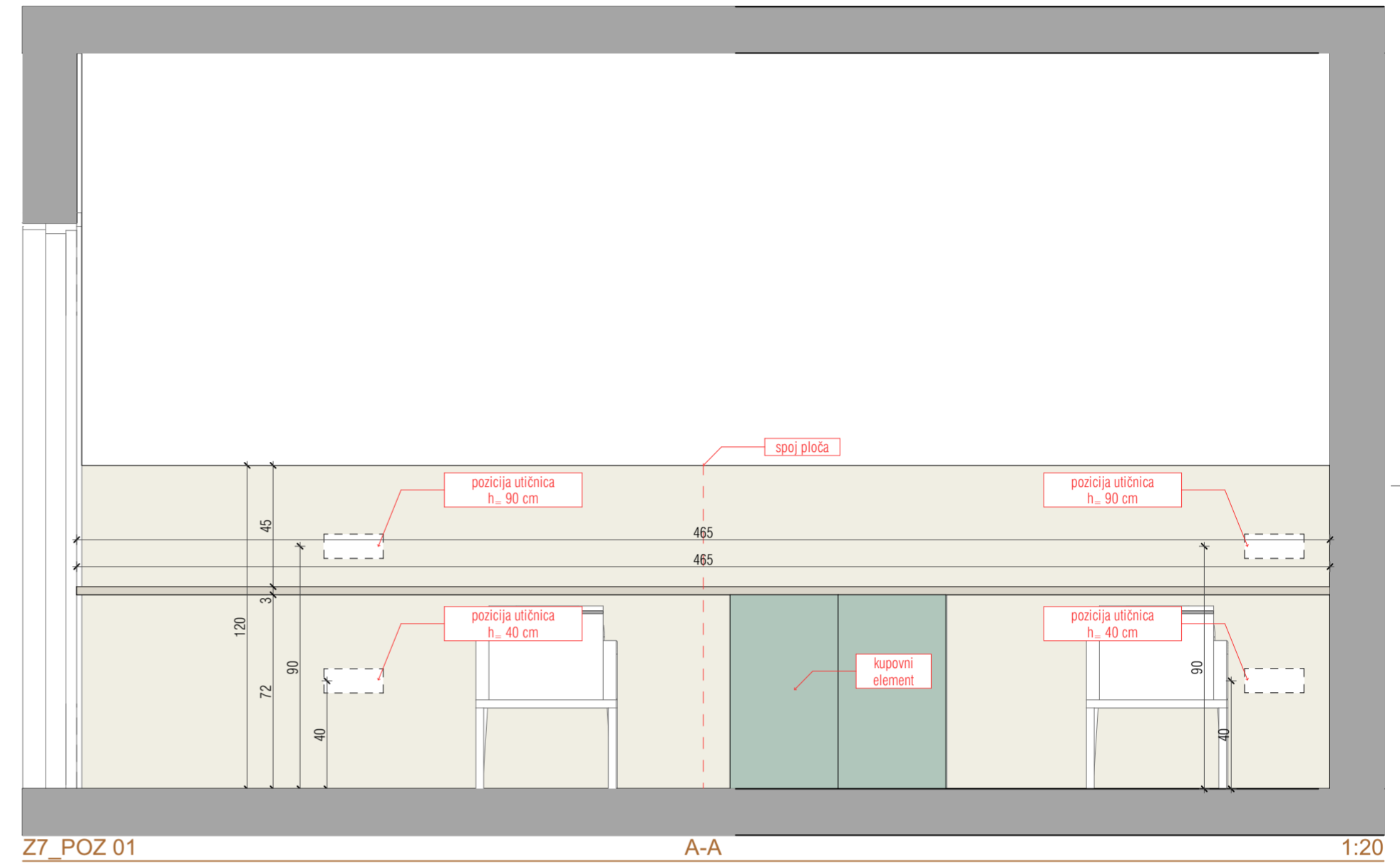
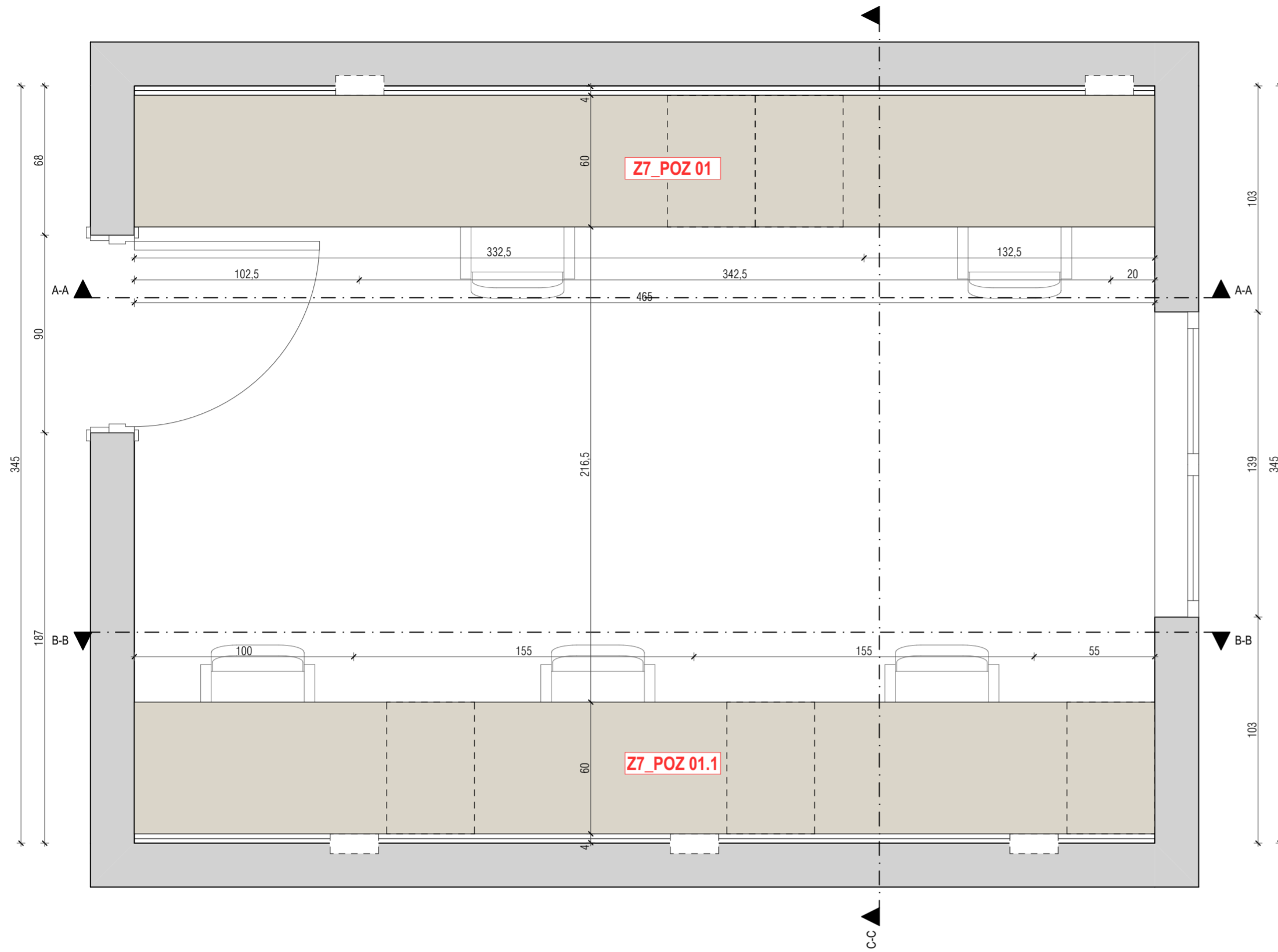

|   |                                 |                |
|---|---------------------------------|----------------|
| <b>TISSA &amp; PARTNERS</b>   |                                 |                |
| naziv građevine<br>1111_EMONIA  |                                 |                |
| investitor<br>Aminess Novigrad  |                                 |                |
| strukovna odrednica / naziv projekta<br>Interijer / Izvedbeni projekt | broj projekta<br>1111-02/25-IZI | datum<br>II/25 |
| projektant<br>ind. diz. Višen Slamar, Nina Štifanić mag. ing. arh.    |                                 |                |
| sadržaj<br>Oprema po mjeri_ZONA_7                                     | mjerilo<br>1:20                 | list<br>D.07   |



|   |                                 |                |
|---|---------------------------------|----------------|
| <b>TISSA &amp; PARTNERS</b>   |                                 |                |
| naziv građevine<br>1111_EMONIA  |                                 |                |
| investitor<br>Aminess Novigrad  |                                 |                |
| strukovna odrednica / naziv projekta<br>Interijer / Izvedbeni projekt | broj projekta<br>1111-02/25-IZI | datum<br>II/25 |
| projektant<br>ind. diz. Višen Slamar, Nina Štifanić mag. ing. arh.    |                                 |                |
| sadržaj<br>Oprema po mjeri_ZONA_7                                     | mjerilo                         | list<br>D.08   |

# ZONA 8

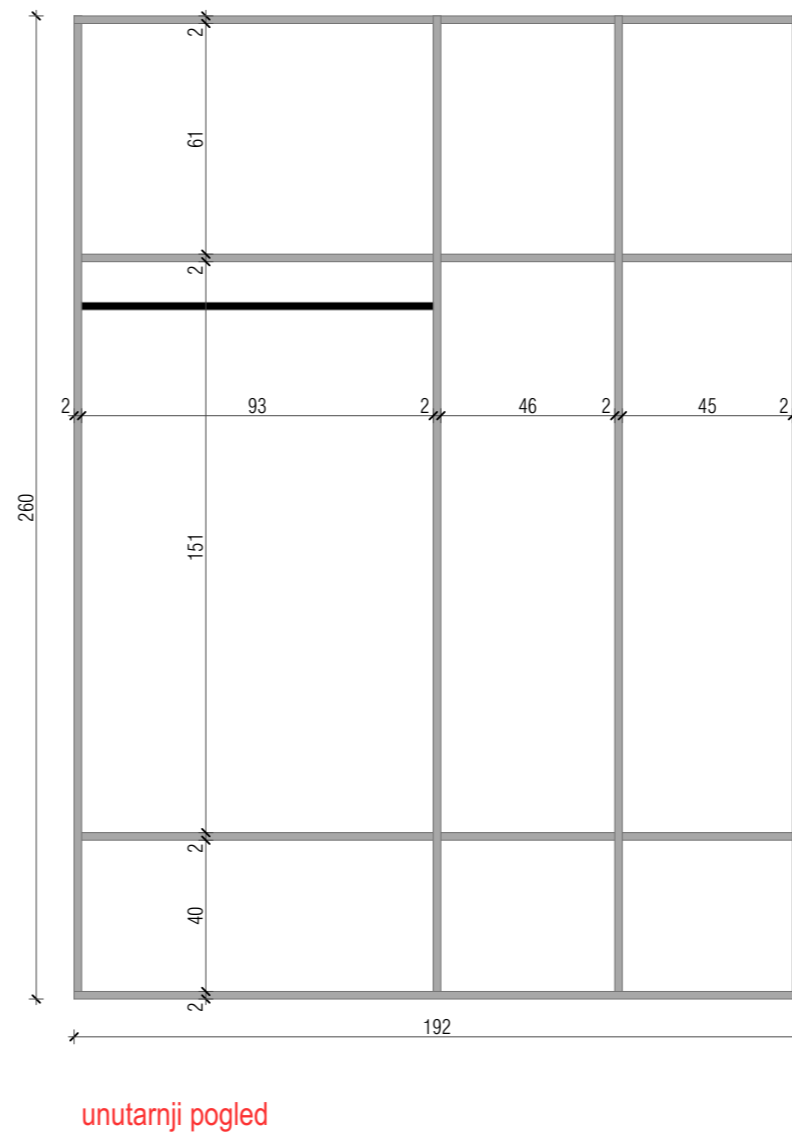
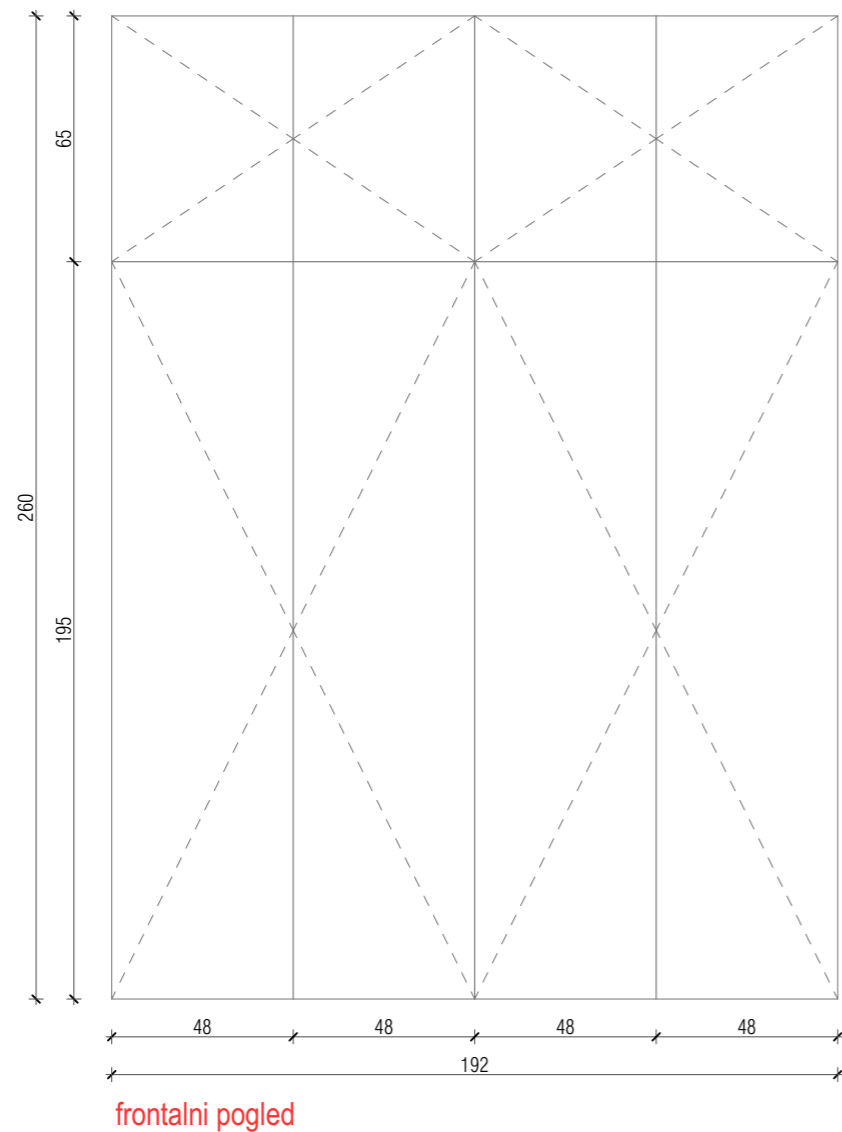
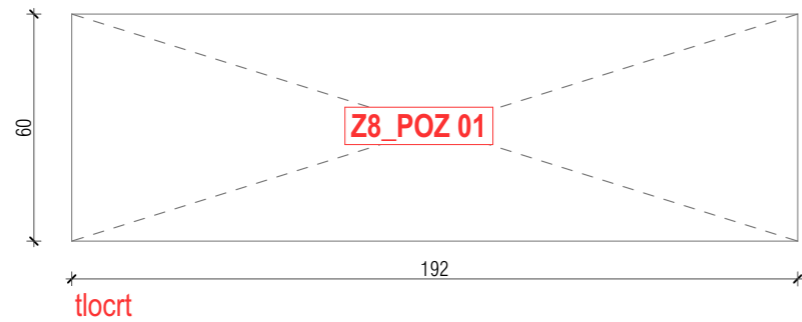

|   |                                 |                |
|---|---------------------------------|----------------|
| <b>TISS &amp; PARTNERS</b>  |                                 |                |
| naziv građevine<br>1111_EMONIA  |                                 |                |
| investitor<br>Aminess Novigrad  |                                 |                |
| strukovna odrednica / naziv projekta<br>Interijer / Izvedbeni projekt | broj projekta<br>1111-02/25-IZI | datum<br>II/25 |
| projektant<br>ind. diz. Višen Slamar, Nina Štifanić mag. ing. arh.    |                                 |                |
| sadržaj<br>Oprema po mjeri_ZONA_8                                     | mjerilo<br>1:20                 | list<br>D.09   |

**ZONA 8**

tlocrt

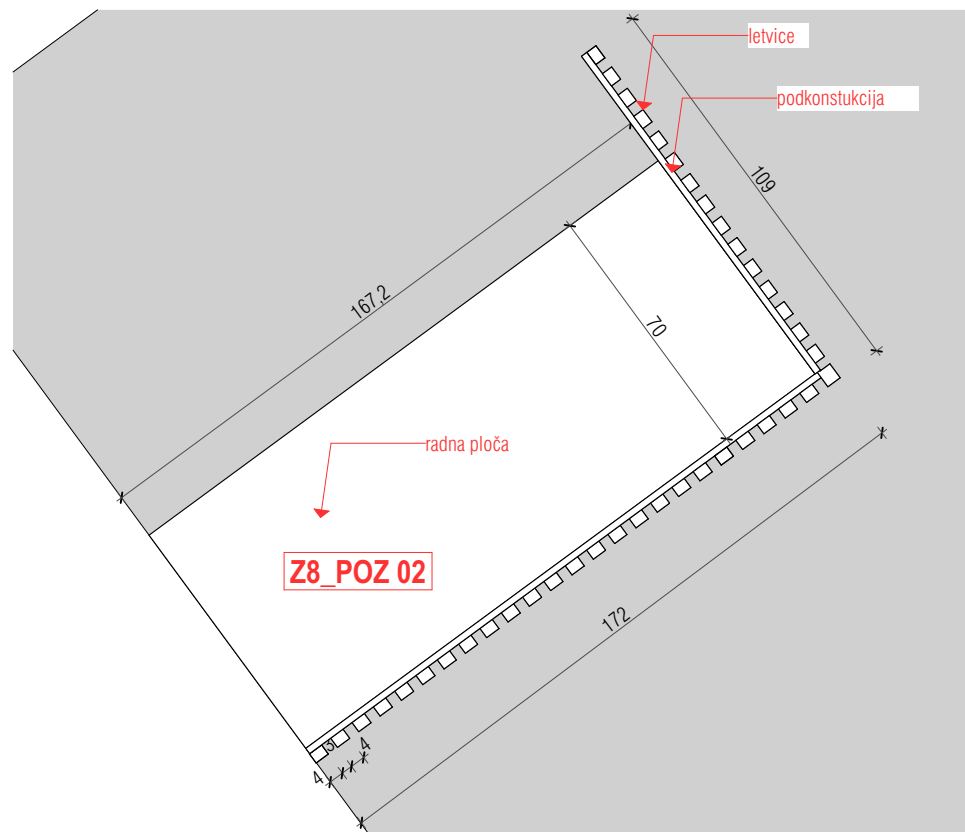

frontalni pogled



bočni pogled



stražnji pogled

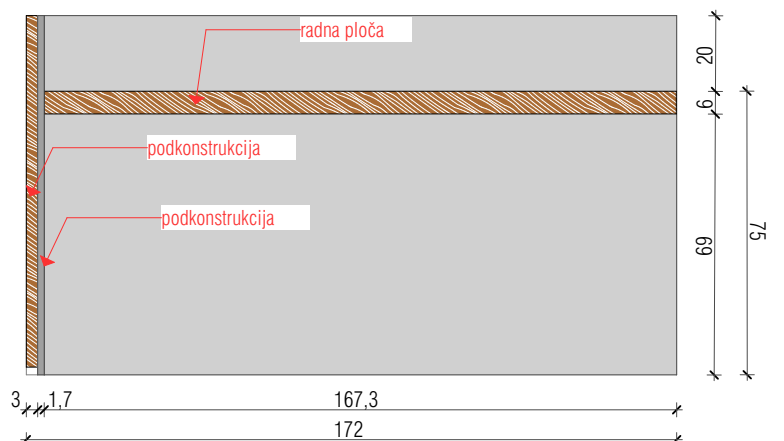



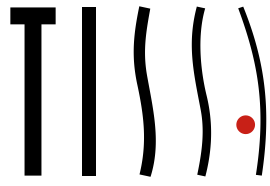

**E\_Textili**

## TISSA & PARTNERS

---

Rade Končara 1a, 52440 Poreč  
tissa@tissa.hr  
+385 52 431 552

[www.tissa.hr](http://www.tissa.hr)

---



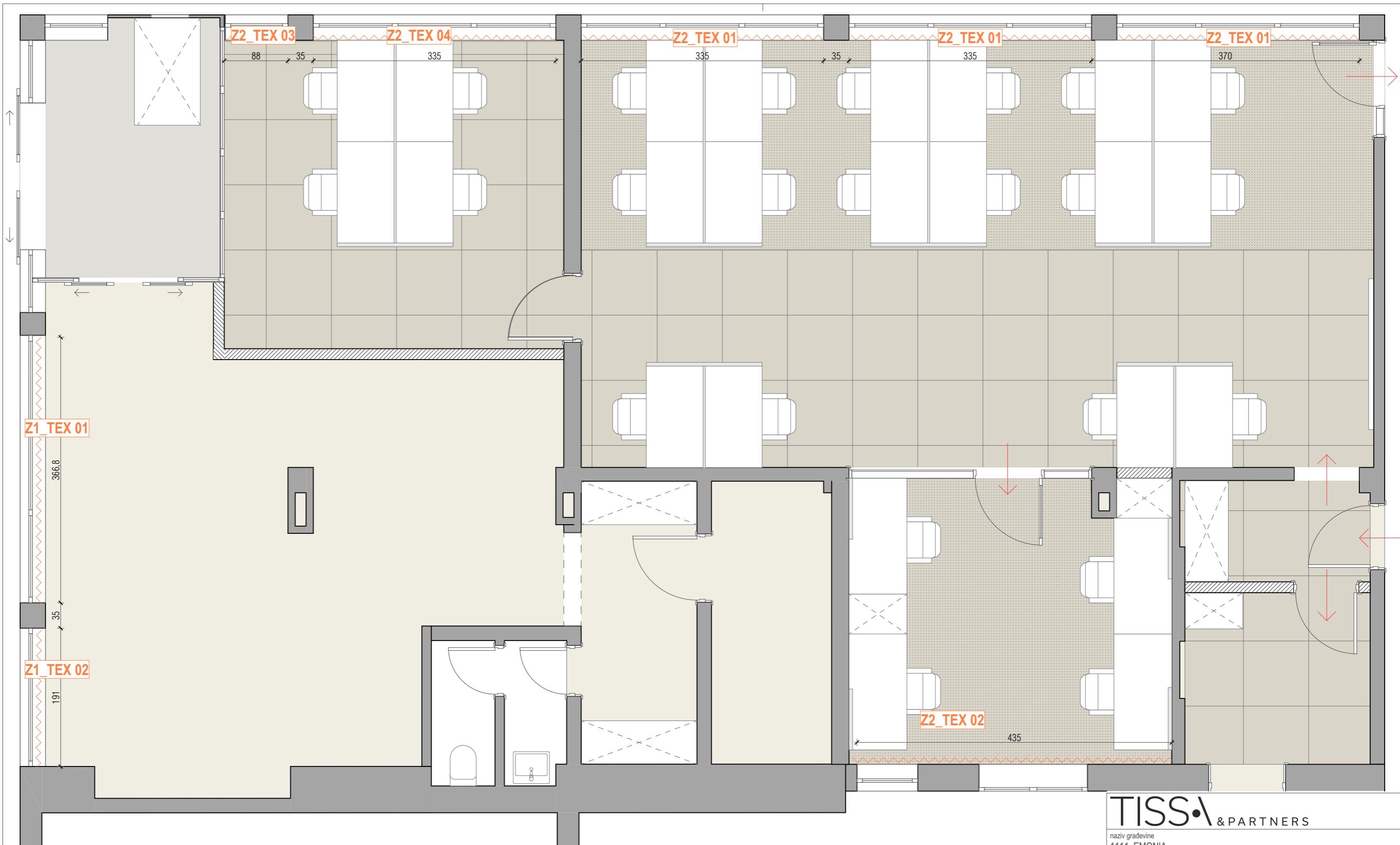

**ZONA 1** **ZONA 2**

**TISSA** & PARTNERS

naziv građevine  
1111\_EMONIA

investitor  
Aminess Novigrad

strukovna odrednica / naziv projekta  
Interijer / Izvedbeni projekt

broj projekta  
1111-02/25-IZI

datum  
II/25

projektant  
ind. diz. Višen Slamar, Nina Štifić mag. ing. arh.

sadržaj  
Textili\_ZONA\_1 i ZONA\_2

mjerilo  
1:50

list  
E.01

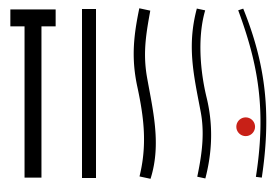

**F\_Rasvjeta**

## TISSA & PARTNERS

---

Rade Končara 1a, 52440 Poreč  
tissa@tissa.hr  
+385 52 431 552

[www.tissa.hr](http://www.tissa.hr)

---





**ZONA 1** **ZONA 2**

**TISS & PARTNERS**

naziv građevine  
1111\_EMONIA

investitor  
Aminess Novigrad

strukovna odrednica / naziv projekta  
Interijer / Izvedbeni projekt

broj projekta  
1111-02/25-IZI

datum  
II/25

projektant  
ind. diz. Višen Slamar, Nina Štifić mag. ing. arh.

sadržaj  
Rasvjeta\_ZONA\_1 i ZONA\_2

mjerilo  
1:50

list  
F.01

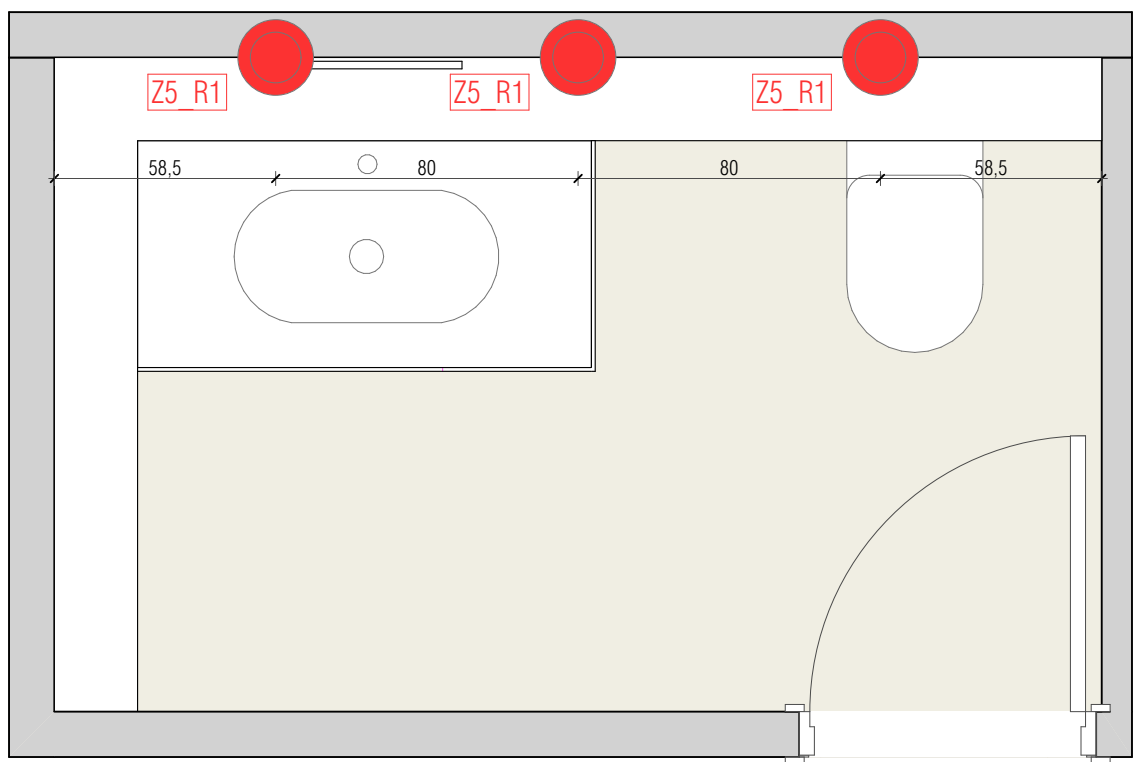
**ZONA 5**

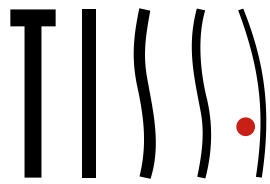

**G\_Sanitarije**

## TISSA & PARTNERS

---

Rade Končara 1a, 52440 Poreč  
tissa@tissa.hr  
+385 52 431 552

[www.tissa.hr](http://www.tissa.hr)

---

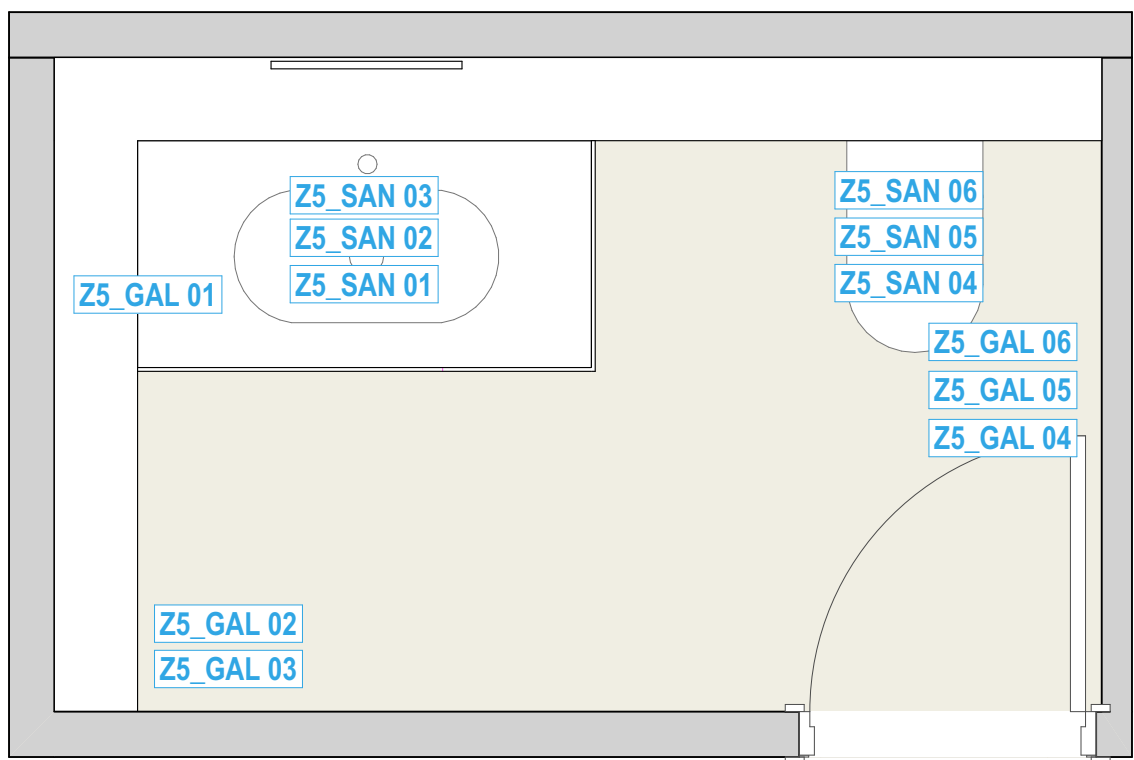

**ZONA 5**

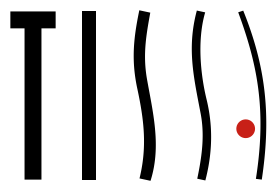

## H\_Signalizacija

### TISSA & PARTNERS

---

Rade Končara 1a, 52440 Poreč  
tissa@tissa.hr  
+385 52 431 552

[www.tissa.hr](http://www.tissa.hr)

---



**ZONA 1**

